

Mora™

INTEGRATED ACOUSTIC CEILING
AND LIGHTING SYSTEM

WORLD TIME ZONES



PEKIN
+11



TOKYO
+10



NEW YORK



LONDON
+5



MOSCOW
+3



FOCAL POINT™

Bringing It All To Light™

A brand of  **legrand**

BLUSH

Create a signature piece and increase occupants' comfort with Mora™

Mora is an integrated acoustic ceiling and lighting system that adds movement and texture to the ceiling plane while optimizing the light levels and acoustics of interior environments. Specification is made easy with Mora Build, Mora Create and Mora Inspire, and the support of our dedicated team.

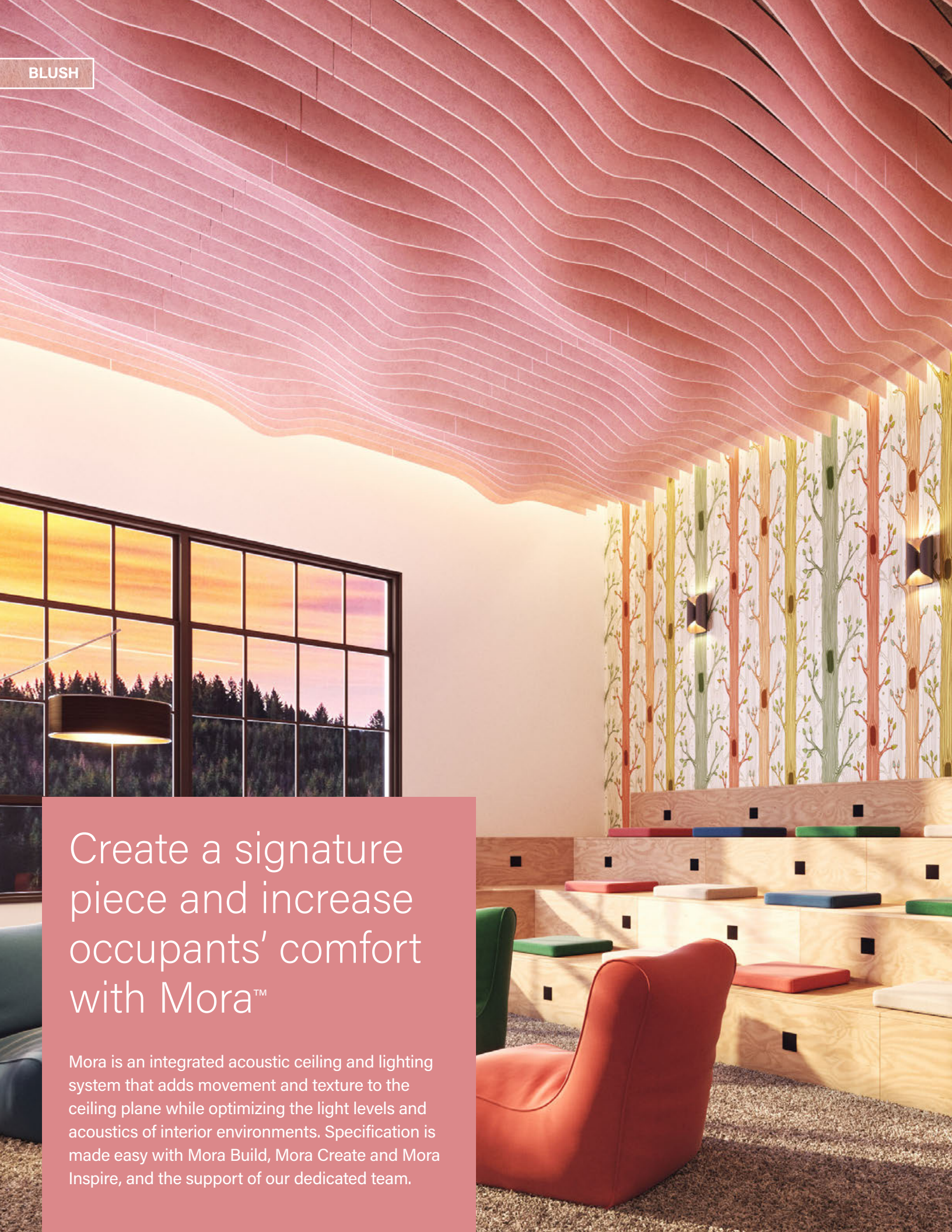



Mora Build

Square modules that are the building blocks of a ceiling system



Mora Create

Standard designs scaled to the dimensions of the room



Mora Inspire

A custom design realized with the help of our team

Advantages of the Mora system

Mora leverages the light engine and acoustic performance of Seem® 1 Acoustic and the flexibility of the TruBlade™ unlit baffle to create exceptional ceiling arrays that not only enhance interior architecture, but also contribute to human comfort and well-being.

- **Integrated lighting and acoustic ceiling system**
 - Eases specification, ordering, delivery, and installation
 - Ensures perfect coordination of the lit and unlit components
- **Design support**
 - Lighting and acoustic calculations
 - Customization
- **Extensive lighting and design options**
 - Multiple shielding, lumen outputs, CCT, CRI, and driver/control options
 - Broad palette of eco-friendly PET felt colors

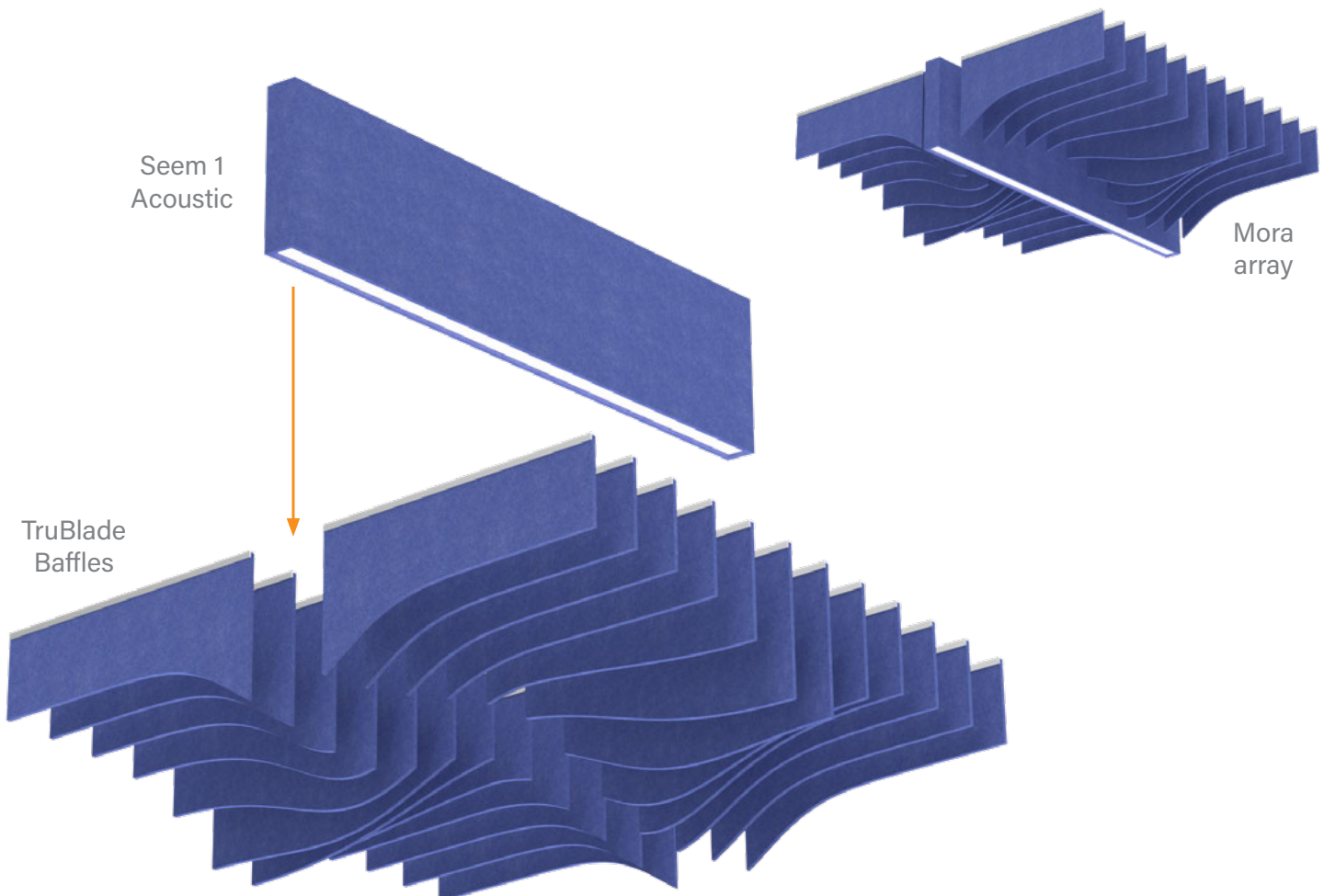

SEEM 1 ACOUSTIC

- Narrow luminaire: 1.5" lens aperture / 2.27" housing width
- Direct only light distribution
- Regress or batwing lens

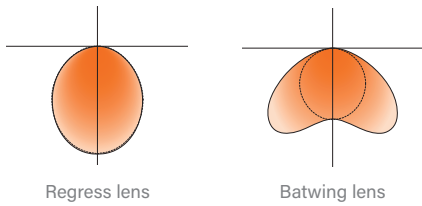

- 100, 200, 300, 400 or 500 lumens per foot
- 3000K, 3500K or 4000K
- 80 or 90 CRI
- 0-10V, DALI or Lutron EcoSystem® dimming
- Uses AirCore™ Technology to maximize sound absorption and minimize ecological impact
- Some designs require a fixed luminaire length, others can be continuous runs

TRUBLADE

- 9mm baffle width
- Designed to optimize affordability, stability and straightness

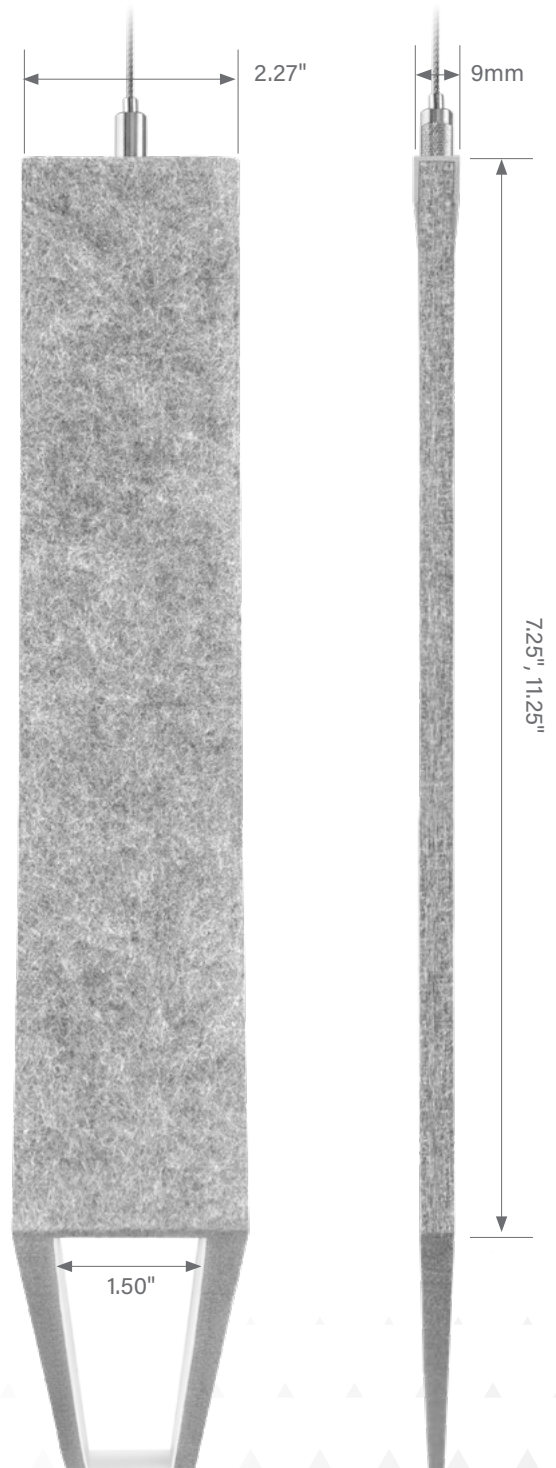

Select your level of customization with Mora Build, Mora Create, and Mora Inspire

MORA BUILD

Mora Build literally offers the building blocks to your next acoustic ceiling. The two standard designs of Arch and Wave are available in nominal square modules from 4 to 8 feet, lit or unlit. Several modules can be combined over large surface areas, resulting in rhythmic and playful ceilings.

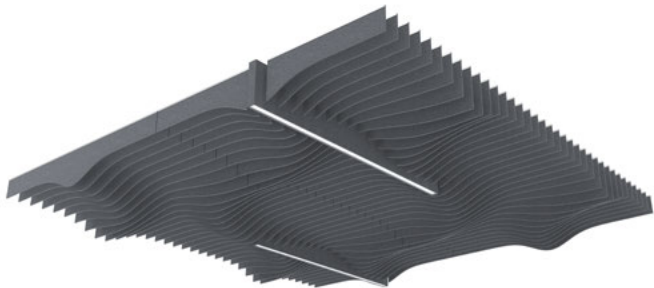

Wave array
2 lit and 2 unlit modules

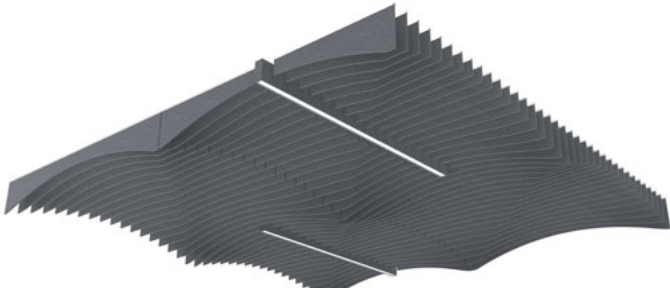

Arch array
2 lit and 2 unlit modules

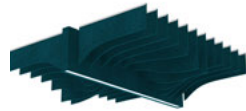

4x4

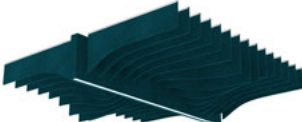

5x5

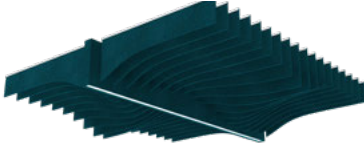

6x6

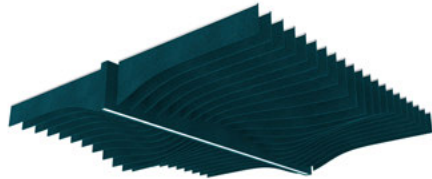

7x7

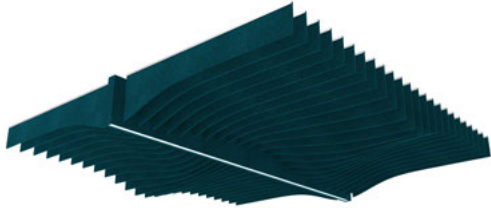

8x8



MORA CREATE

Mora Create gives you the freedom to design custom-sized arrays to fit the exact dimensions of your room using three designs: Ripple, Radiate, or Alpine. Each offers a unique visual aesthetic and allows for placement of continuous luminaires to fulfill the lighting requirements of the space.



Ripple



Alpine

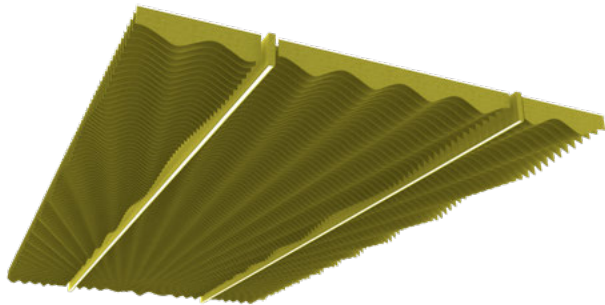

Radiate

MORA INSPIRE

Let your imagination run wild with the support of our design and engineering team. We will turn your inspiration into a showpiece ceiling. Contact us at acoustic.solutions@focalpointlights.com to discuss your project.

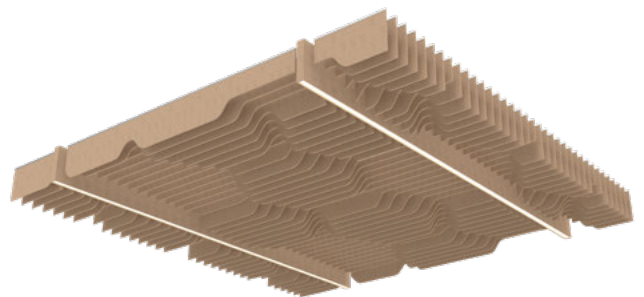

How to specify Mora Build

1. Determine the overall ceiling dimensions for the system.



2. Select your preferred design: Arch or Wave.

3. Select A or B style modules, or a combination of both.

The sequence of the baffles is reversed for A and B styles, yielding a totally different visual effect.

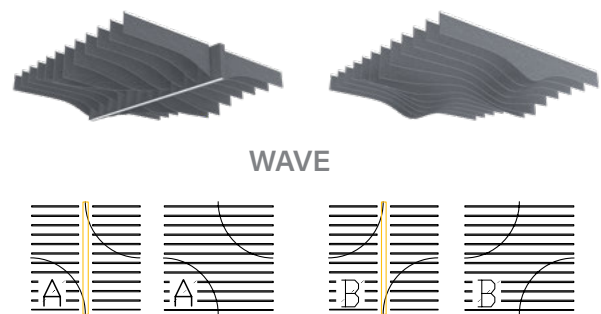
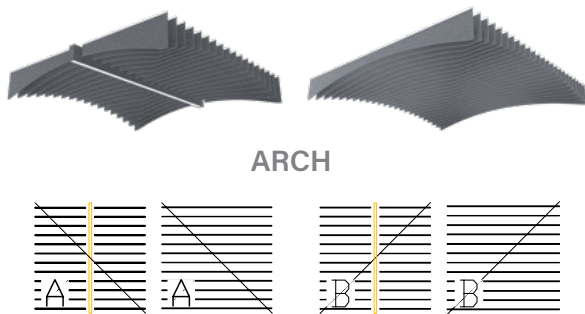

4. Determine the lighting requirements to select the module sizes.

Use the chart to view available options for luminaire on-center spacing.

Example: For 12ft on-center spacing, 4x4 or 6x6 modules can be selected.

LIT AND UNLIT MODULE CONFIGURATIONS	MODULE SIZE				
	4x4	5x5	6x6	7x7	8x8
	4ft	5ft	6ft	7ft	8ft
	8ft	10ft	12ft	14ft	16ft
	12ft	15ft	18ft		
	16ft				

- Select the on-center spacing of the baffles based on acoustic and aesthetic needs.

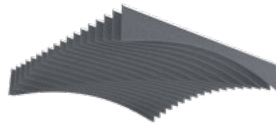

4" on center

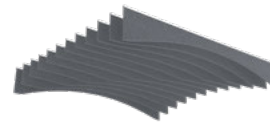

6" on center



12" on center

That's it, you've just built a ceiling array that will optimize lighting and sound levels!



Higher Education Multi-Purpose

- System Dimensions: 36ft x 30ft (1,080ft²)
- Design: Wave
- Styles: Alternating A & B modules create a circular pattern
- Modules: 5x5 modules with 5ft & 10ft luminaire spacing
- Baffle spacing: 4" on center

SYSTEM CONFIGURATION

42 total modules
 12 AMR-WVA-5x5-4OC, 9 AUMR-WVA-5x5-4OC
 12 AMR-WVB- 5x5-4OC, 9 AUMR-WVB-5x5-4OC

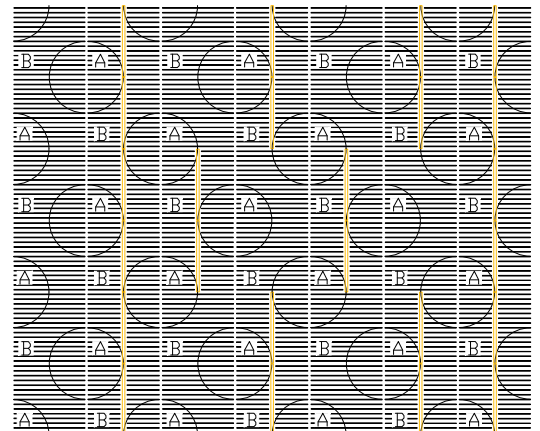



Cafe

1. System Dimensions: 24ft x 40ft (960ft²)
2. Design: Arch
3. Style: All A
4. Modules: 8x8 modules with 8ft & 16ft luminaire spacing
5. Baffle spacing: 4" on center

SYSTEM CONFIGURATION

15 total modules

5 AMR-AHA-8x8-4OC, 10 AUMR-AHA-8x8-4OC

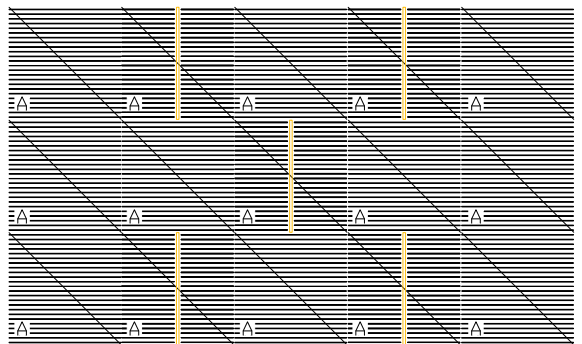



How to specify Mora Create

1. Determine the overall ceiling dimensions for the system.



2. Select your preferred design:

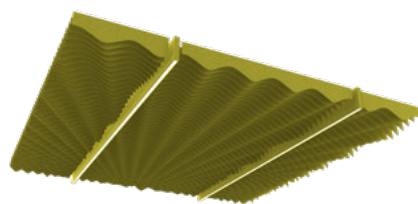

RADIATE

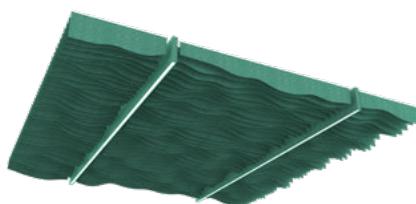

RIPPLE



ALPINE

3. Determine the lighting requirements to specify the placement of the luminaires.

4. Select the on-center spacing of the baffles based on acoustic and aesthetic needs.

5. Send us the filled out form attached to the Mora Create cut sheet. That's where the dialog will start with our team.

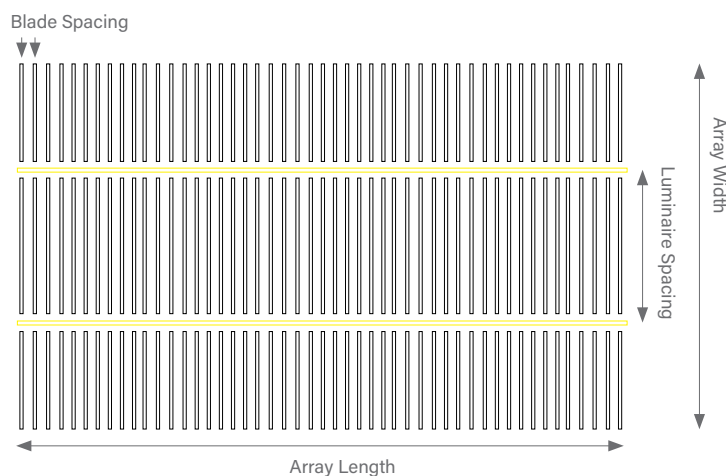

We will provide plan and 3D views of each Mora Create system as we work through the details with you. Our consultative approach will ensure perfect control of the process from the initial discussion, through to design and engineering, to the delivery of an easy-to-install integrated ceiling system.

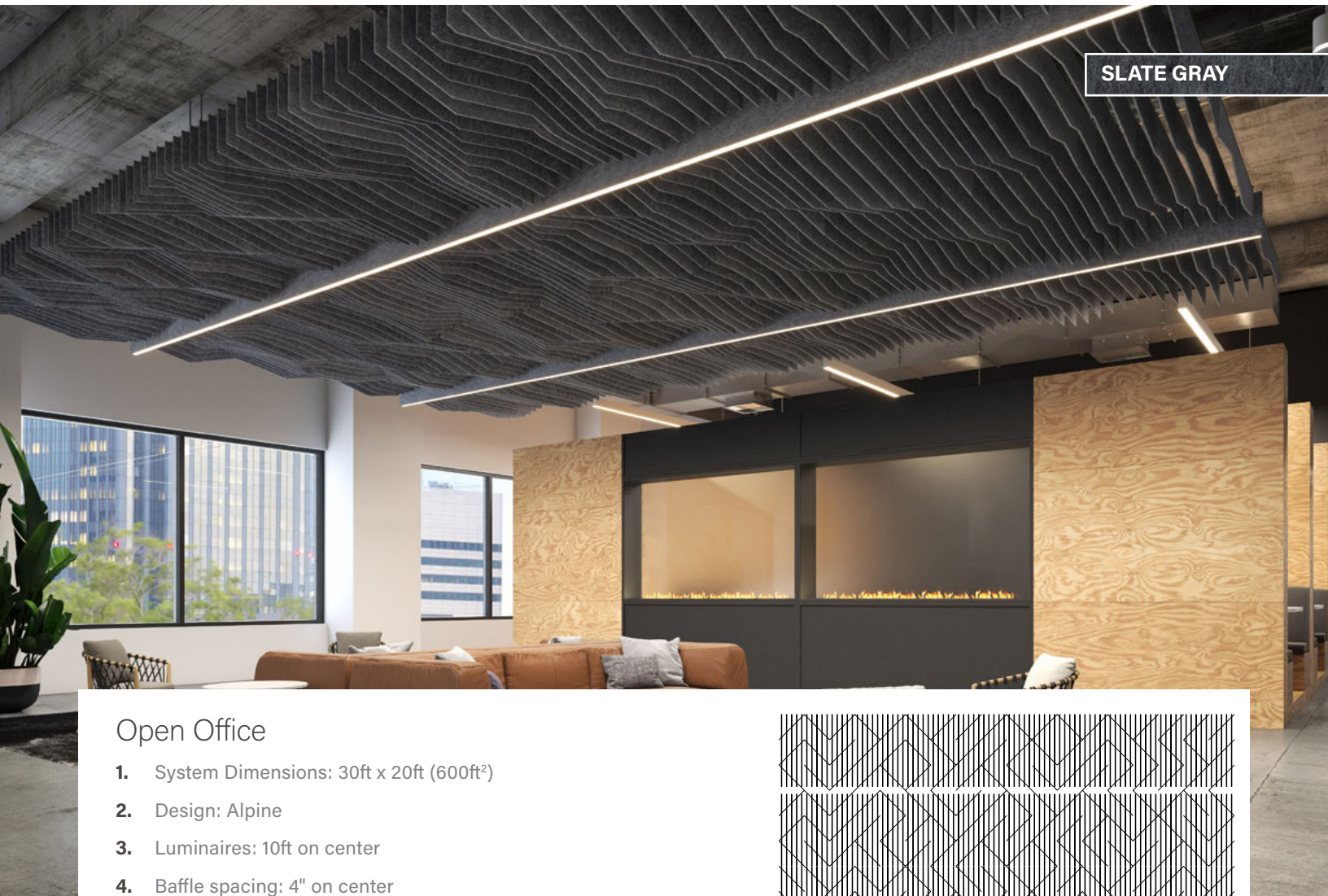
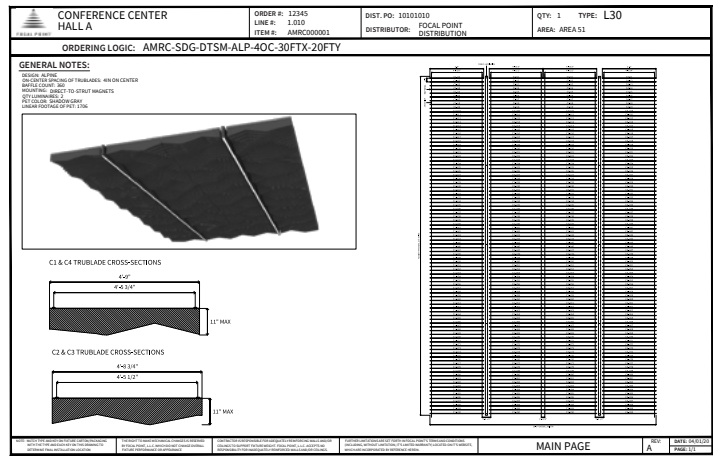

Open Office

1. System Dimensions: 30ft x 20ft (600ft²)
2. Design: Alpine
3. Luminaires: 10ft on center
4. Baffle spacing: 4" on center

SYSTEM CONFIGURATION

AMRC-ALP-30FTX-20FTY-4OC-PPD-10FTOC

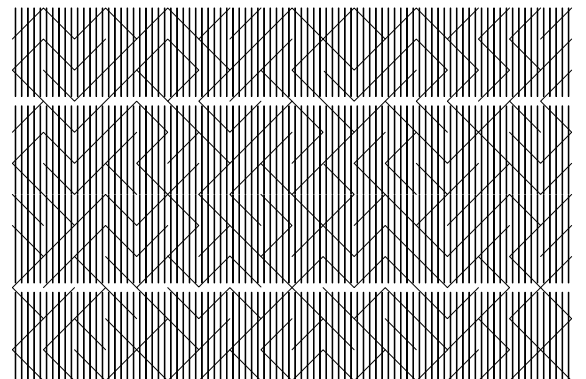

SEAFOAM





Library

1. System Dimensions: 50ft x 22ft (1,100ft²)
2. Design: Ripple
3. Luminaires: 8ft on center
4. Baffle spacing: 6" on center

SYSTEM CONFIGURATION

AMRC-RPL-50FTX-22FTY-6OC-PPD-8FTOC

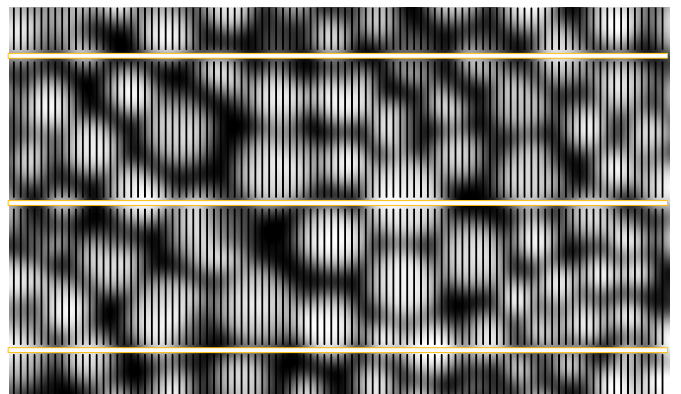

LIME GREEN

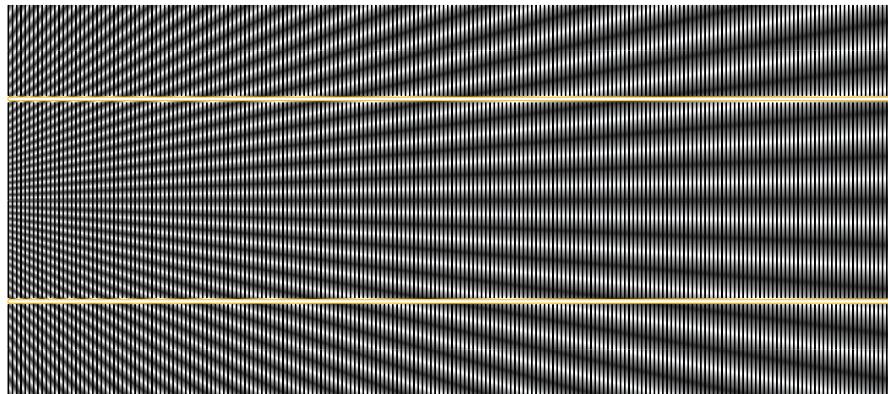

Atrium

1. System Dimensions: 86ft x 35ft (3,010ft²)
2. Design: Radiate
3. Luminaires: 16ft on center
4. Baffle spacing: 4" on center

SYSTEM CONFIGURATION

AMRC-RDT-86FTX-35FTY-4OC-PPD-16FTOC

How to specify Mora Inspire

Looking for a real unique ceiling array?
Contact our team at
acoustic.solutions@focalpointlights.com
to discuss your idea.

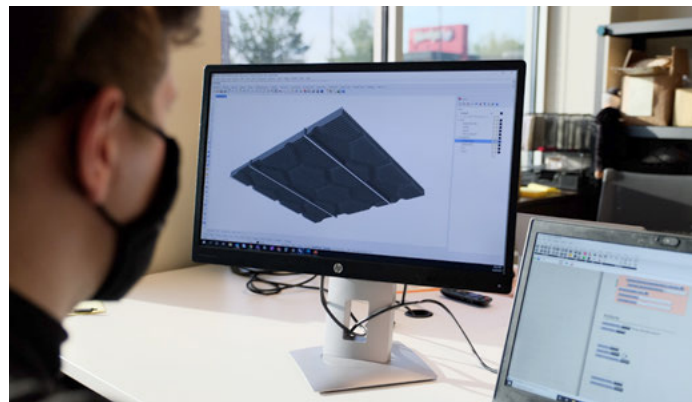

SILVER GRAY

Airport Lounge

1. System Dimensions: 36ft x 30ft (1080ft²)
2. Design: Customer supplied, inspired by honeycomb
3. Luminaires: 10ft on center
5. Baffle spacing: 6ft on center

SYSTEM CONFIGURATION

Custom



Contribute to building and occupants' health

The acoustic performance will vary based on the configuration of each array. Refer to the ASTM C423 test reports for more information.

- 9mm thickness
- Polyester containing at least 50% of post-consumer recycled content, 100% recyclable
- Declare Certified, LBC Red List Free
- ASTM E-84 Class A / CAN ULC S102 fire rating
- Moisture resistant
- Polyethylene Terephthalate (PET) felt can be vacuumed to remove dust. For spills and stains, blot away any excessive moisture from spills off the material as quickly as possible. Wipe the area with a damp cloth and blot dry. If the staining persists, apply a small quantity of carpet cleaner mixed with water on a dampened cloth. Blot well after each application. Make sure to test this procedure in a discreet area before you use it in a visible area.

Declare.

9mm PET Felt
Focal Point, LLC

Final Assembly: Chicago, Illinois, USA
Life Expectancy: 30 Years
End of Life Options: Salvageable/Reusable in its Entirety, Recyclable (100%)

Ingredients:

PET; Octadecanamide, N,N'-1,2-ethanediylibis; Stearic Acid; Benzenamine, 4-(1-methyl-1-phenylethyl)-N-[4-(1-methyl-1-phenylethyl)phenyl]-; Benzenesulpropanoic acid, 3,5-bis(1-dimethylethyl)-4-hydroxy-, octadecyl ester; Titanium dioxide

Living Building Challenge Criteria: Compliant

I-13 Red List:

LBC Red List Free % Disclosed: 100% at 100ppm
 LBC Red List Approved VOC Content: Not Applicable
 Declared

I-10 Interior Performance: CDPH Standard Method v1.1-2010

I-14 Responsible Sourcing: Not Applicable

FPL-0001

Exp: 01 FEB 2022

Original Issue Date: 2020

MANUFACTURER RESPONSIBLE FOR LABEL ACCURACY
INTERNATIONAL LIVING FUTURE INSTITUTE™ living-future.org/declare

PINEAPPLE

Healthcare

1. System Dimensions: 4ft x 40ft (160ft²)
2. Design: Arch
3. Style: Alternating A & B styles
4. Modules: 4x4 modules, 4ft luminaire spacing
5. Baffle spacing: 6" on center

SYSTEM CONFIGURATION

27 total modules

14 AMR-AHA-PNA-44-6OC, 13 AUMR-AHB-PNA-44-6OC



Speed up installation

Each Mora array ships with clear installation instructions, a spacer tool, labeling of each baffle, and packaging according to the installation sequence. This is to help facilitate the work of the installer, reduce the risk for errors, and minimize labor costs. Clips or magnets make installation a breeze; cable suspension is also available.

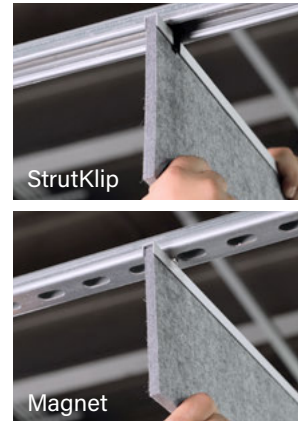
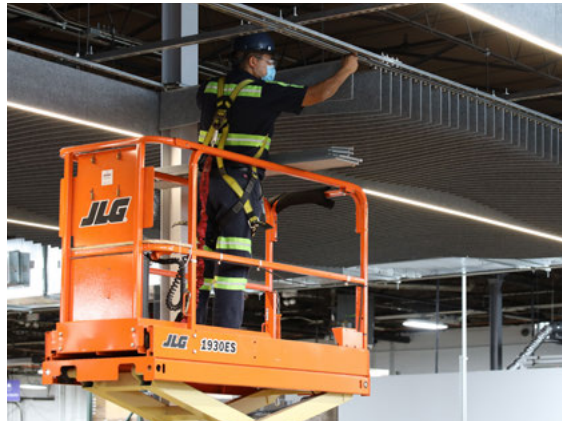
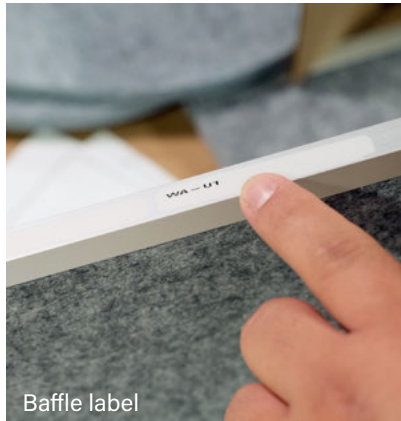

MOUNTING OPTIONS

- Direct-to-strut luminaire with StrutKlip or magnet blade mounting

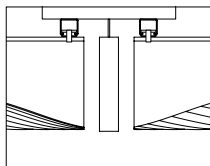

StrutKlip

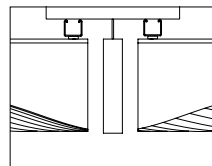

Magnet

- Suspended luminaire with StrutKlip or magnet blade mounting

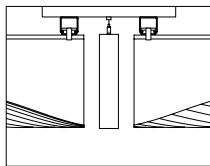

StrutKlip

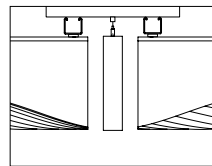

Magnet

- Suspended luminaire and baffles

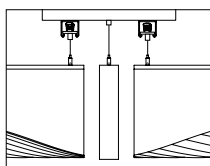

Cable

SPACER TOOL



One spacer tool allows for 4", 6" or 12" spacing.

SPRINKLER INTEGRATION

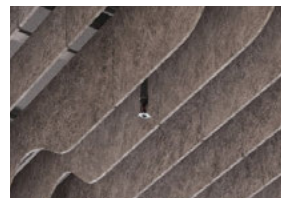

All installations must comply with International Building Code (IBC) sections 903.2.1 through 903.2.12 and your local fire codes.

PET Colors

STANDARD COLORS

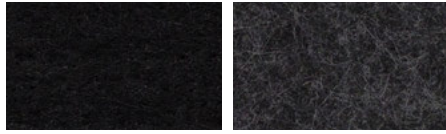

PURE BLACK PBK CHARCOAL GRAY CHG

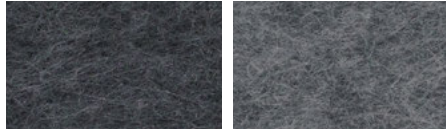

SLATE SLT SHADOW GRAY SDG

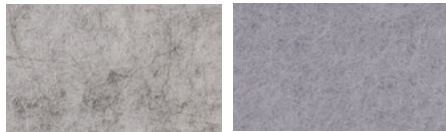

SILVER GRAY SLG PEARL ICE PIC

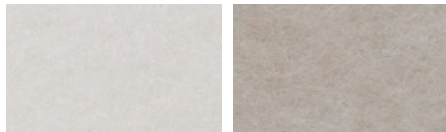

CLASSIC WHITE CWH NATURAL LINEN NTL

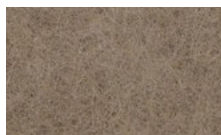

HAZELWOOD HZW

PREMIUM COLORS*

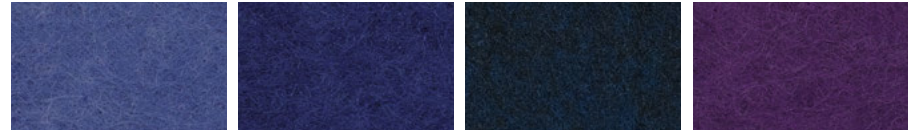

CORNFLOWER BLUE CFB DENIM BLUE DNB MIDNIGHT BLUE MNB DEEP PURPLE DPP

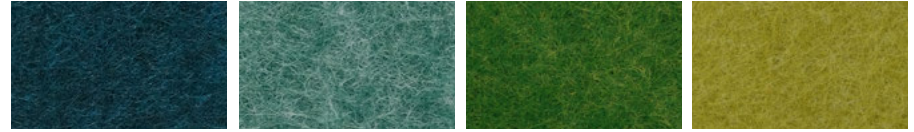

DEEP WATER DWT SEAFOAM SFM EMERALD GREEN EMG LIME GREEN LMG

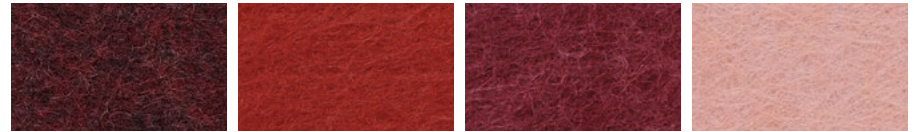

BRICK RED BRD CHERRY RED CHR BERRY BRY BLUSH BLS



CARROT CRT PINEAPPLE PNA



CINNAMON CNM LIMESTONE LMS

For more information on how to specify acoustic systems, or for general inquiries regarding the Focal Point Acoustic Solutions offering, please email acoustic.solutions@focalpointlights.com or contact your Focal Point representative.



FOCAL POINT®

Bringing It All To Light™



Front cover:

Mora Create Radiate, 86ft x 35ft (3010ft²),
4" on-center blade spacing,
16ft on-center luminaire spacing,
Lime Green

Page 1:

Mora Build Wave, 18ft x 18ft (324ft²),
B style, 6x6 modules,
6" on-center blade spacing,
Blush