

Seem[®] 2 Drywall/Hard/Specialty Ceiling

LED

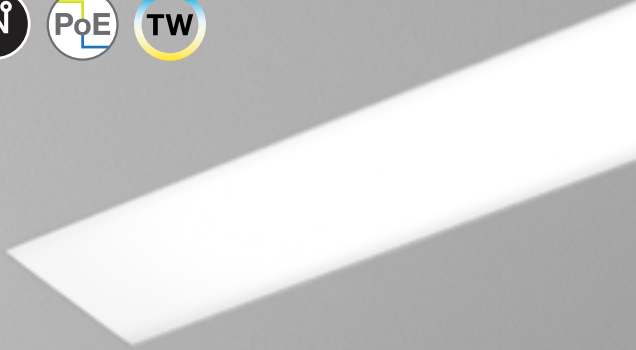

trim flange



corner detail



regress lens



grid ceiling companion



wall to ceiling companion



perimeter companion



suspended & wall mount companions

DIMENSIONAL DATA

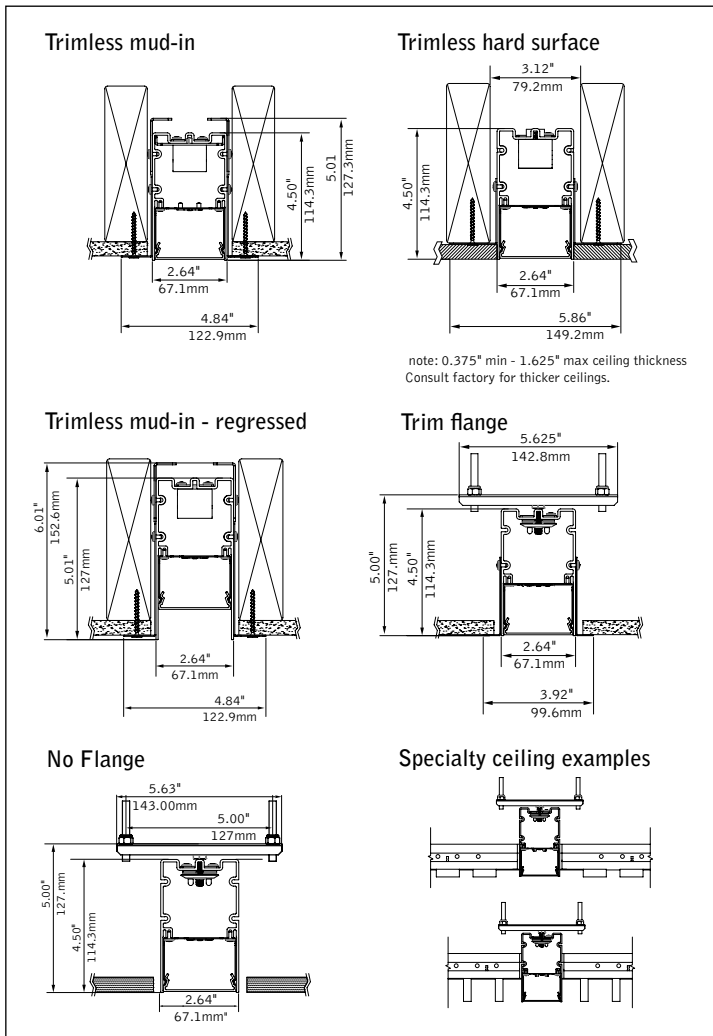

FEATURES

- Narrow extruded aluminum 2.5" aperture recessed slot LED.
- Integrates with ceiling or wall in a variety of mounting styles for a clean, unobtrusive aesthetic.
- Individual units and continuous runs in 1" increments.
- Frosted acrylic lens provides uninterrupted illumination, without pixels or shadows.
- LED position and lens material optimized to provide the perfect blend of high performance and visual comfort.
- Tunable White: Supports human activity, well-being, and preferences with a light quality that evolves throughout the day.
- Connected Solutions: Integrates with wired and wireless building lighting control systems.
- PoE compatible: Integrates with Power over Ethernet lighting systems via standard, low-voltage wires.

DISTRIBUTIONS

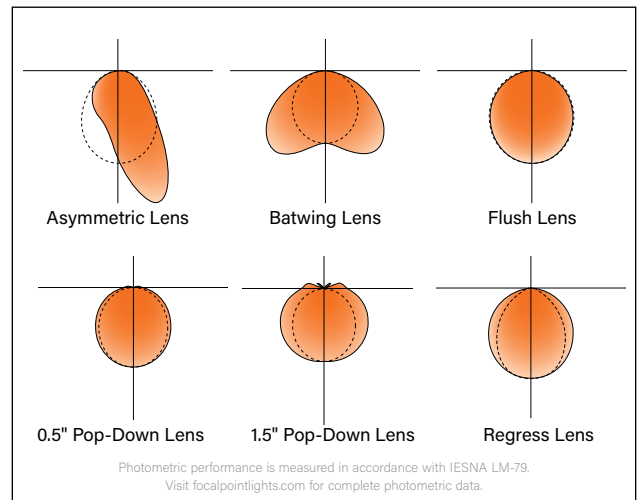

4' PERFORMANCE CHART

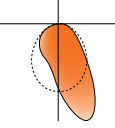
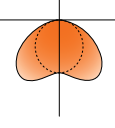
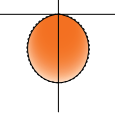
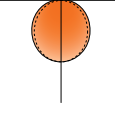
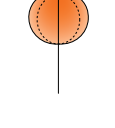
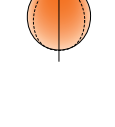
Shielding	Lumens per Foot	Delivered Lumens	Tested System Watts	LPW
Asymmetric Lens 	125LF	561	5.7	99
	250LF	1172	9.6	122
	375LF	1784	13.9	128
	500LF	2390	18.3	130
	625LF	2989	23.7	126
	750LF	3582	28.4	126
	875LF	4167	33.4	125
Batwing Lens 	125LF	538	5.7	95
	250LF	1124	9.6	117
	375LF	1711	13.9	123
	500LF	2293	18.3	125
	625LF	2867	23.7	121
	750LF	3436	28.4	121
	875LF	3997	33.4	120
Flush Lens 	125LF	504	5.7	89
	250LF	1052	9.6	109
	375LF	1601	13.9	115
	500LF	2145	18.3	117
	625LF	2682	23.7	113
	750LF	3214	28.4	113
	875LF	3739	33.4	112
Pop Down 0.5" Lens 	125LF	472	5.7	83
	250LF	985	9.6	102
	375LF	1500	13.9	108
	500LF	2010	18.3	110
	625LF	2513	23.7	106
	750LF	3011	28.4	106
	875LF	3503	33.4	105
Pop Down 1.5" Lens 	125LF	470	5.7	83
	250LF	981	9.6	102
	375LF	1493	13.9	107
	500LF	200	18.3	109
	625LF	2502	23.7	106
	750LF	2997	28.4	105
	875LF	3487	33.4	104
Regress Lens 	125LF	472	5.7	83
	250LF	986	9.6	102
	375LF	1501	13.9	108
	500LF	2010	18.3	110
	625LF	2514	23.7	106
	750LF	3012	28.4	106
	875LF	3505	33.4	105
1000LF	3991	33.4	104	

Based on 3500K, 4' lengths. Lumen multiplier: Continuous runs = 0.93 Lumen output may vary +/- 5%. Actual wattage may vary +/- 5%.

STANDARD WHITE

Luminaire Series

Seem 2 LED FSM2L

Shielding

Asymmetric Lens AS

Batwing Lens BW

Flush Lens FL

Pop Down 0.5" Lens PD05

Pop Down 1.5" Lens PD15

(2' to 8' Individual Units Only)

Regress Lens SR

Lumen Output

125 Lumens per foot 125LF

(LD1, L11 & D11 driver only. 4' minimum. Not available on patterns.)

250 Lumens per foot 250LF

(3' minimum with LH1. Not available on patterns with LH1)

375 Lumens per foot 375LF

500 Lumens per foot 500LF

625 Lumens per foot 625LF

750 Lumens per foot 750LF

875 Lumens per foot 875LF

1000 Lumens per foot 1000LF

Color Temperature

2700K, 80+ CRI or 90+ CRI 27K or 927K

3000K, 80+ CRI or 90+ CRI 30K or 930K

3500K, 80+ CRI or 90+ CRI 35K or 935K

4000K, 80+ CRI or 90+ CRI 40K or 940K

Circuits & Zones

1 Circuit, non-emergency 1C

Consult Ordering Guide on page 3 for multiple

circuiting and zoning options

Voltage

120/277 UNV Volt UNV

347 Volt (L11 and LD1 driver only) 347V

Low voltage LV

Control System & Dimming Level

0-10V - 10% Dimming LD1

0-10V - 1% Dimming L11

Low Voltage, PoE compatible LVN

(No driver. Not available with EM or EC. LV Voltage only.)

Lutron Hi-Lume EcoSystem (LDE1) -* LH1

1% Dimming

DALI 1% Dimming* D11

*(Not available with patterns.)

Wattstopper Fixture Sensor** LMFS1

Low Density - 1% Dimming

Wattstopper Fixture Sensor** LMFS2

High Density - 1% Dimming

Lutron Athena Wireless Sensor** LAWS

Enlighted Smart Sensor - 1% Dimming** ENL1

WaveLinx Pro - 1% Dimming** WLXP

** (3' minimum length. 7' minimum with ECD/EM. Not available with pop-down lenses. See sensor layout guide)

Ceiling Configuration

No Flange for specialty ceilings NF

(Ex. slat, panel, cloud systems.)

Trim Flange Drywall TF

Trim Flange Wood TFW

Mud-in Trimless, 1/2" Drywall XF1

Mud-in Trimless, 5/8" Drywall XF2

Mud-in Trimless, any Drywall Thickness XFF

Non-Drywall Hard Surface XFN

Hard Surface, Wood XFW

Factory Options

(See Ordering Guide for ordering details for DC, EC, EM & ECD.)

Chicago Plenum CP

(Not available with Flex Whip)

Daylight Circuit _DC

Emergency Circuit _EC

Emergency Battery Pack† _EM

Emergency Control Device‡ _ECD

† (4' minimum. 6' minimum with patterns. 120/277 Volt only. Not available at corners.)

6' New York City Flex Whip (120V) FNY1

6' New York City Flex Whip (277V) FNY2

6' Flex Whip FW

Finish

Matte White Housing WH

Luminaire Length

Specify luminaire/row length in 1" increments _ft_in

(2' minimum. Leave blank for patterns.)

Pattern Options

(4' minimum length)

'L' pattern A' x B'

'U' pattern A' x B' x C'

Rectangular pattern A' x B' R

(Consult factory for other pattern options)



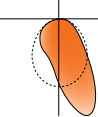
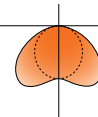
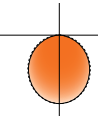
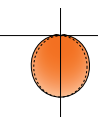
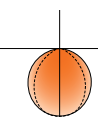

4' PERFORMANCE CHART

Shielding	Lumens per Foot	Delivered Lumens	Tested System Watts	LPW
Asymmetric Lens 	125LF	500	7.25	79.3
	250LF	1000	12.90	93.1
	375LF	1500	18.55	98.5
	500LF	2000	18.3	101.1
	625LF	2500	24.21	102.5
	750LF	3000	29.86	106.8
	875LF	3500	34.34	107.5
Batwing Lens 	1000LF	4000	45.08	107.8
	125LF	500	7.25	76.0
	250LF	1000	12.90	89.2
	375LF	1500	18.55	94.4
	500LF	2000	18.3	96.9
	625LF	2500	24.21	98.3
	750LF	3000	29.86	102.4
Flush Lens 	875LF	3500	34.34	103.0
	1000LF	4000	39.71	103.3
	125LF	500	7.25	69.0
	250LF	1000	12.90	80.9
	375LF	1500	18.55	85.7
	500LF	2000	18.3	87.9
	625LF	2500	24.21	89.2
Pop Down 0.5" Lens 	750LF	3000	29.86	92.9
	875LF	3500	34.34	93.5
	1000LF	4000	39.71	93.7
	125LF	500	7.25	66.2
	250LF	1000	12.90	77.7
	375LF	1500	18.55	82.2
	500LF	2000	18.3	84.4
Pop Down 1.5" Lens 	625LF	2500	24.21	85.6
	750LF	3000	29.86	89.2
	875LF	3500	34.34	89.7
	1000LF	4000	39.71	90
	125LF	500	7.25	65.5
	250LF	1000	12.90	76.9
	375LF	1500	18.55	81.4
Regress Lens 	500LF	2000	18.3	83.5
	625LF	2500	24.21	84.7
	750LF	3000	29.86	88.3
	875LF	3500	34.34	88.8
	1000LF	4000	39.71	89.1
	125LF	500	7.25	60.4
	250LF	1000	12.90	70.9

Based on 2700K, 80CRI, 4' lengths. Lumen output may vary +/- 5%. Actual wattage may vary +/- 5%

Lumen Multiplier		Wattage Multipliers	
CRI	Multiplier	CCT	Multiplier
80+	1.00	2700K	1.00
90+	0.89	3000K	0.92
		3500K	0.88
		4000K	0.86
		5000K	0.85
		5700K	0.87



TUNABLE WHITE

Luminaire Series

Seem 2 LED FSM2L

Shielding

- Asymmetric Lens AS
- Batwing Lens BW
- Flush Lens FL
- Pop Down 0.5" Lens PD05
- Pop Down 1.5" Lens PD15
- Regress Lens SR

(Housing height 5.5" Ceiling applications only)

Lumen Output

- 125 Lumens per foot 125LF
- 250 Lumens per foot 250LF
- 375 Lumens per foot 375LF
- 500 Lumens per foot 500LF
- 625 Lumens per foot 625LF
- 750 Lumens per foot 750LF
- 875 Lumens per foot 875LF
- 1000 Lumens per foot 1000LF

Color Temperature

- Tunable White: 2700-6500K, 80+ CRI 2765T
- Tunable White: 2700-6500K, 90+ CRI 92765T

Circuits & Zones

- 1 Circuit, non-emergency 1C
- Consult Ordering Guide on page 3 for multiple circuiting and zoning options _C_Z_DL

Voltage

- 120/277 UNV Volt UNV
- 347 Volt Support 347V
- Low voltage LV

Control System & Dimming Level

- Lutron T-Series - 1% Dimming* LT1
- DALI 1% Dimming* D1TW

*Consult factory, extended lead time apply.

Ceiling Configuration

- No Flange for specialty ceilings (Ex. slat, panel, cloud systems.) NF
- Trim Flange Drywall TF
- Trim Flange Wood TFW
- Mud-in Trimless, 1/2" Drywall XF1
- Mud-in Trimless, 5/8" Drywall XF2
- Mud-in Trimless, any Drywall Thickness XFF
- Non-Drywall Hard Surface XFN
- Hard Surface, Wood XFW

Factory Options

(See Ordering Guide for ordering details for DC, EC, EM & ECD.)

Chicago Plenum

(Not available with Flex Whip)

- Daylight Circuit _DC
- Emergency Circuit _EC
- Emergency Battery Pack† _EM
- Emergency Control Device† _ECD

†(4' minimum. 6' minimum with patterns. 120/277 Volt only. Not available at corners.)

- 6' New York City Flex Whip (120V) FNY1
- 6' New York City Flex Whip (277V) FNY2
- 6' Flex Whip FW

Finish

- Matte White Housing WH

Luminaire Length

Specify luminaire/row length in 1" increments _ft_in
(2" minimum. Leave blank for patterns.)

Pattern Options

(4' minimum length)

- 'L' pattern A' x B'
- 'U' pattern A' x B' x C'
- Rectangular pattern A' x B' R

(Consult factory for other pattern options)

SPECIFICATIONS

LED System

Proprietary linear LED module incorporates premium LEDs on a robust platform to achieve excellent thermal management. LEDs are placed to promote a uniform appearance. Available in 2700K, 3000K, 3500K or 4000K with CRI>80 or CRI>90, 3 SDCM. 3500K and 4000K with CRI>90 have a cyanosis observation index (COI) of 3.3 or less. LED modules and drivers are replaceable from below.

Construction

One piece extruded aluminum housing, 20 Ga. steel end caps. Housing for new construction applications. Flush lens weights: 4' unit: 12.2 lbs., 8' unit: 24.4 lbs. Regress lens weights: 4' unit: 13.2 lbs., 8' unit: 26.4 lbs..

Optic

Reflectors fabricated of 22 Ga. steel finished in High Reflectance White powder coat. Extruded acrylic lens .07" thick with satin finish, up to 8' continuous.

Electrical

Luminaires are pre-wired with factory installed branch circuit wiring and over-molded quick connects. Standard 120-277V constant current driver includes 0-10V analog dimming. Power factor > .9. PoE compatible: Integrates with Power over Ethernet lighting systems via standard, low-voltage wires. PoE runs require an independent PoE node and power feed for each luminaire section.

DETAILS

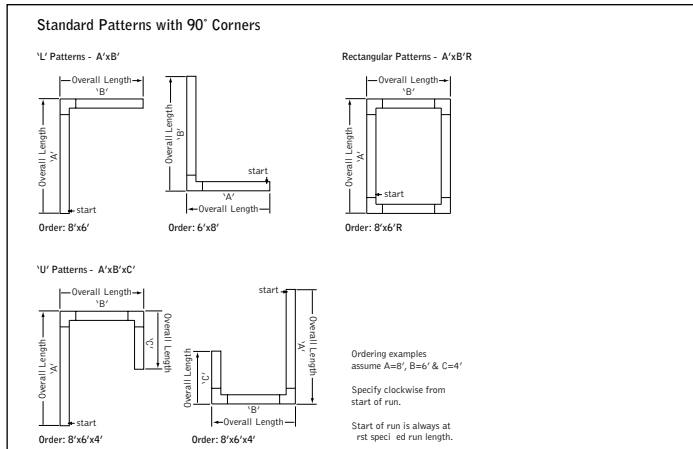

Emergency

Emergency Battery output - 10 watts for 90 minutes. Maximum mounting height: 17.9ft. Emergency Circuit with Connected Solutions (LMFS1, LMFS2, ENL1, WLXP) shipped standard with leads to connect UL924 compliant device, by others.

Labels

UL and cUL listed. Suitable for Dry or Damp Locations, indoor use only.

Finish

Polyester powder coat applied over a multi-stage pre-treatment.

Lumen Maintenance

Reported: L70 at >61,000 hours	Calculated: L70 at 385,000 hours
L90 at >61,000 hours	L90 at 103,000 hours

Derived from EPA TM-21 calculator. Based on typical conditions, consult factory for additional data.

Reliability

At Focal Point, our products are designed to stand the test of time. Each luminaire is engineered using superior components, manufactured with the utmost care and rigorously tested. Contact us for reliability data.

Warranty

LED system rated for operation in ambient environments up to 25°C. 5-year limited warranty.

Focal Point provides flexibility in meeting the needs of each project by integrating with several building lighting control systems. A variety of sensors, drivers and other components can be specified that allow the luminaires to communicate with wired and wireless networks. All zoning can be digitally reconfigured through the application software. Daylight harvesting, occupancy sensing, integration with HVAC systems, and individual controls enable the monitoring and modulating of light levels and temperature in order to save energy, reduce costs and maximize occupants' comfort. All Connected Solutions luminaires require a compatible building control system.†

Connected Solution	Ordering Code	Model #**	Protocol	Compatible Networks*	Occupancy & Daylight	Temperature Reporting	Communication to Luminaire	Drivers
 WATTSTOPPER®	LMFS1	LMFS-601 & LMFI-111	DLM Wireless	DLM	Integrated	No	Wireless	Advance by Signify
	LMFSD	LMFS-601						Optotronic by eldoLED (Dexal)
	WLXP	OEM-WAA	WaveLinx Wireless	WaveLinx Pro Trellix	Integrated	No	Wireless (WaveLinx Pro Wireless Area Controller)	Advance by Signify
	D11	Specified Driver	DALI	Crestron Züm Wireless & SpaceBuilder	Enabled	No	Wired	eldoLED ECOdrive
	ENL1	SU-5E-IOT	Enlighted RF	Enlighted	Integrated	Yes	Wireless	Advance by Signify
	LAWS	A-WN-D01-OCC-WH	DALI, 0-10V	Athena Wireless	Integrated	No	Wireless	Advance by Signify
	LH1	LDE1	EcoSystem	Quantum, Energi Savr Node, Energi TriPak	Enabled	No	Wired	Lutron Hi-Lume

*Not all compatible networks may be listed. **For performance data and additional control system details please visit the connected solutions manufacturer websites. Primary drivers are listed in **bold**. To specify a particular driver please consult factory. †Controls systems supplied by others.

Ordering Guide



Direct Only Linear Circuitry, Zones & Factory Options

HOW TO USE THIS GUIDE

Fill out the worksheet on the following page to specify your requirements for circuitry, zones, and factory options.

Refer to the run chart for standard run configurations, consult factory for custom configurations.

Complete the Totals / Ordering Codes at the bottom of the worksheet and add to your ordering logic on the cut sheet.

Submit the worksheet along with your order.

TOTAL RUN LENGTH: <u>32ft</u>		JOB NAME: _____			FIXTURE TYPE: _____			
HOUSING SECTION	SECTION LENGTH	SHARED ELECTRICAL FEED, NORMAL POWER			FACTORY OPTIONS			
		SWITCHING CIRCUIT	DIMMING ZONE	DAYLIGHT ZONE	SEPARATE ELECTRICAL FEEDS			EM
					DAYLIGHT CIRCUIT	EMERGENCY CIRCUIT	ECD	
1	8	1C	1Z					1EM
2	8	2C	2Z					
3	8	2C	2Z					
4	8				1DC			
Totals / Ordering Codes		2C	2Z		1DC			1EM

ORDERING: FSM4L-FL-625LF-35K- **2C2Z** -UNV-LD1-G2- **1DC-1EM** -WH-32ft

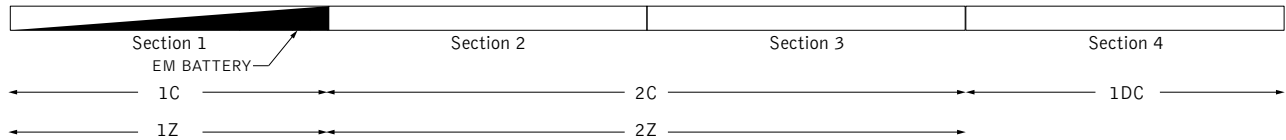

KEY	
C = Switching Circuit Switched Hot / Shared Neutral	DC = Daylight Circuit Switched Hot / Separate Neutral
Z = Dimming Zone Dimming Control Wires	EC = Emergency Circuit Switched Hot / Separate Neutral
DL = Daylight Zone Daylight Dimming Control Wires	EM = Emergency Battery Unswitched Hot / Shared Neutral
	ECD = Emergency Control Device Unswitched Hot / Separate Neutral

DEFAULTS

- Zones and Factory Options illuminate entire sections from 4' to 8' in length.
- One shared or isolated circuit and zone required per housing section.
- Limit of one EM or ECD per housing section.
- Additional electrical feed required for applications greater than three shared circuits and zones.
- Each DC, EC and ECD require an additional electrical feed.
- ECD not available in the same housing section as EC.
- Longer lead times and additional pricing may apply for custom run configurations.

CUSTOM LENGTHS

- If partial illumination of emergency or daylight section is required, indicate in ordering guide and add "partial illumination" in Order Notes. Drawing required.
- Engineering validation required, longer lead times may apply.

Ordering Guide Worksheet

Linear Circuitry, Zones & Factory Options



FOCAL POINT®

TOTAL RUN LENGTH: _____		JOB NAME: _____			FIXTURE TYPE: _____			
HOUSING SECTION	SECTION LENGTH	SHARED ELECTRICAL FEED, NORMAL POWER			FACTORY OPTIONS			EM
		SWITCHING CIRCUIT	DIMMING ZONE	DAYLIGHT ZONE	SEPARATE ELECTRICAL FEEDS			
DAYLIGHT CIRCUIT	EMERGENCY CIRCUIT				ECD			
1								
2								
3								
4								
5								
6								
7								
8								
9								
10								
11								
12								
13								
14								
15								
16								
17								
18								
19								
20								
Totals / Ordering Codes								

WORKSHEET

Combine to create Circuits & Zones ordering code

Enter as individual Factory Options

RUN CHART

Run length (ft)	Housing Configuration Section Lengths	Run length (ft)	Housing Configuration Section Lengths	Run length (ft)	Housing Configuration Section Lengths	Run length (ft)	Housing Configuration Section Lengths
9	5 + 4	21	8 + 8 + 5	33	8 + 8 + 8 + 5 + 4	45	8 + 8 + 8 + 8 + 8 + 5
10	6 + 4	22	8 + 8 + 6	34	8 + 8 + 8 + 6 + 4	46	8 + 8 + 8 + 8 + 8 + 6
11	7 + 4	23	8 + 8 + 7	35	8 + 8 + 8 + 7 + 4	47	8 + 8 + 8 + 8 + 8 + 7
12	8 + 4	24	8 + 8 + 8	36	8 + 8 + 8 + 8 + 4	48	8 + 8 + 8 + 8 + 8 + 8
13	8 + 5	25	8 + 8 + 5 + 4	37	8 + 8 + 8 + 8 + 5		
14	8 + 6	26	8 + 8 + 6 + 4	38	8 + 8 + 8 + 8 + 6		
15	8 + 7	27	8 + 8 + 7 + 4	39	8 + 8 + 8 + 8 + 7		
16	8 + 8	28	8 + 8 + 8 + 4	40	8 + 8 + 8 + 8 + 8		
17	8 + 5 + 4	29	8 + 8 + 8 + 5	41	8 + 8 + 8 + 8 + 5 + 4		
18	8 + 6 + 4	30	8 + 8 + 8 + 6	42	8 + 8 + 8 + 8 + 6 + 4		
19	8 + 7 + 4	31	8 + 8 + 8 + 7	43	8 + 8 + 8 + 8 + 7 + 4		
20	8 + 8 + 4	32	8 + 8 + 8 + 8	44	8 + 8 + 8 + 8 + 8 + 4		

Standard run configurations, consult factory for custom configurations.