

# Seem® 1

LED INDIRECT ONLY

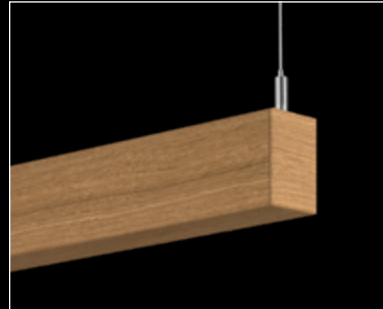

The Naturals collection - Chestnut shown

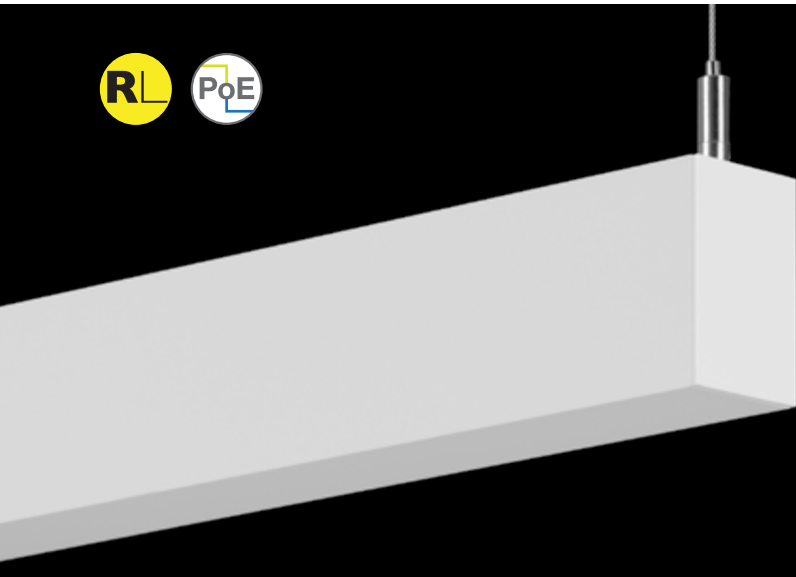
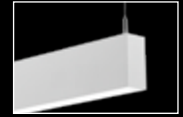

lensed companion

## DIMENSIONAL DATA

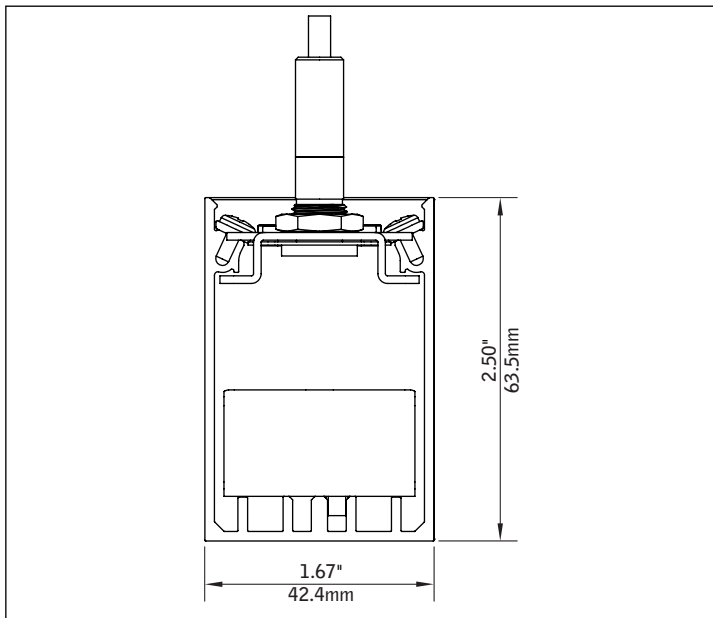

### Mounting Information

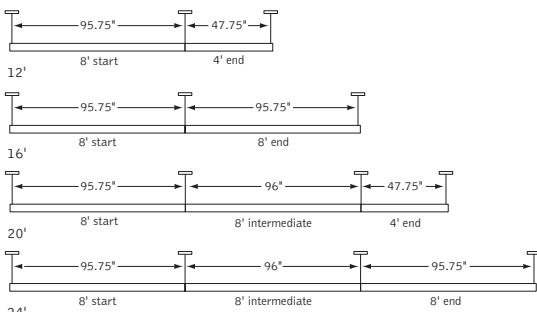

Consult factory for additional row length information.

## FEATURES

Narrow extruded aluminum 1.5" linear indirect LED suspended luminaire.

Individual units and continuous runs in 1' increments.

Choice of output levels and light distributions to meet a wide variety of application needs.

Features Right Light lumen levels allowing lumen and wattage design flexibility.

PoE compatible: Integrates with Power over Ethernet lighting systems via standard, low-voltage wires.

Available with The Naturals, a series of finishes that exude biophilic beauty.

## PERFORMANCE

4' Asymmetric Optic 625 Lumens per foot	4' Batwing Optic 625 Lumens per foot	4' Dust Cover 625 Lumens per foot
<b>Total Lumen Output: 2500lm</b>	<b>Total Lumen Output: 2500lm</b>	<b>Total Lumen Output: 2500lm</b>
<b>Total System Watts: 19W</b>	<b>Total System Watts: 19W</b>	<b>Total System Watts: 18W</b>

Photometric performance is measured in accordance with IESNA LM-79. Visit focalpointlights.com for complete photometric data.

**DETAILS**

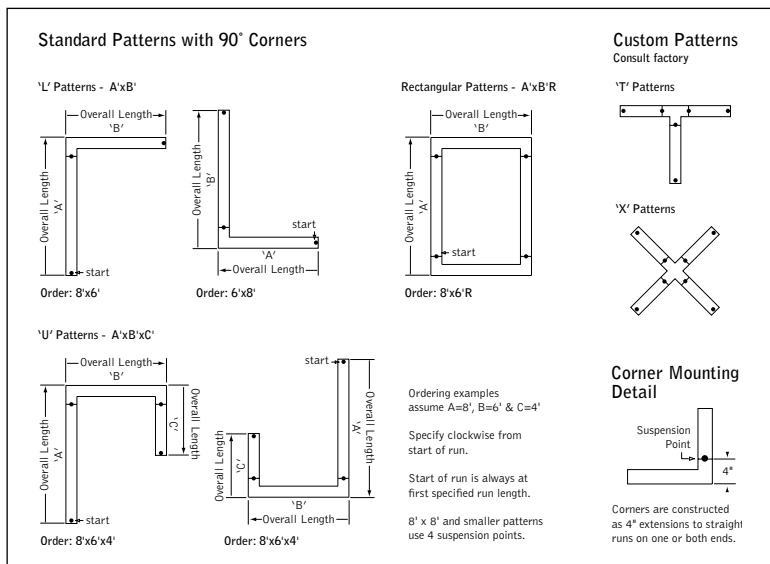

**SPECIFICATIONS**

**LED System**

Proprietary linear LED module incorporates premium LEDs on a robust platform to achieve excellent thermal management. LEDs are placed to promote a uniform appearance. Available in 2700K, 3000K, 3500K or 4000K with both 80 and 90 CRI options. 3500K and 4000K with CRI>90 have a cyanosis observation index (COI) of 3.3 or less. LED modules and drivers are replaceable from above. Color accuracy <3 SDCM.

**Construction**

One piece extruded aluminum housing. Cast aluminum end caps. 8' unit weight: 12lbs.

**Optic**

Reflectors fabricated of 20 Ga. steel finished in Matte White powder coat.

**Electrical**

Luminaires are pre-wired with factory installed branch circuit wiring and over-molded quick connects. Standard 120-277V constant current driver includes 0-10V analog dimming. Power factor > .9. PoE compatible: Integrates with Power over Ethernet lighting systems via standard, low-voltage wires. PoE runs require an independent PoE node and power feed for each luminaire section.

**Backup Battery / Auxillary Circuit**

Backup battery output - 10 watts for 90 minutes. EM/EC options do not meet UL 924 requirements.

**Labels**

UL and cUL Listed. Suitable for Dry or Damp Locations, indoor use only.

**Finish**

Polyester powder coat applied over a multi-stage pre-treatment. The Naturals: 100% low VOC vinyl. Canopy and cord white as standard.

**Lumen Maintenance**

Reported: L70 at >61,000 hours                      Calculated: L70 at 470,000 hours  
 L90 at >61,000 hours                                      L90 at 115,000 hours

Derived from EPA TM-21 calculator. Based on typical conditions, consult factory for additional data.

**Reliability**

At Focal Point, our products are designed to stand the test of time. Each luminaire is engineered using superior components, manufactured with the utmost care and rigorously tested. Contact us for reliability data.

**Warranty**

LED system rated for operation in ambient environments up to 25°C. 5-year limited warranty.

**4' PERFORMANCE CHART**

See page 3.

**ORDERING**

<b>Luminaire Series</b>	<b>FSM11S</b>
Seem 1 LED Indirect	FSM11S
<b>Shielding</b>	
Asymmetric Optic	AS
Batwing Optic	BW
Dust Cover	DC
<b>Indirect Distribution</b>	
250 Lumens per foot	250LF
375 Lumens per foot	375LF
500 Lumens per foot	500LF
625 Lumens per foot	625LF
800 Lumens per foot	800LF
1000 Lumens per foot	1000LF
1250 Lumens per foot	1250LF
<b>Color Temperature</b>	
2700K, 80+ CRI or 90+ CRI	27K or 927K
3000K, 80+ CRI or 90+ CRI	30K or 930K
3500K, 80+ CRI or 90+ CRI	35K or 935K
4000K, 80+ CRI or 90+ CRI	40K or 940K
<b>Circuits &amp; Zones</b>	
1 Circuit, non-emergency	1C
Consult Ordering Guide for multiple circuiting and zoning options	_C_Z_DL
<b>Voltage</b>	
120/277 UNV Volt	UNV
347 Volt (LD1 driver only)	347
Low Voltage	LV
<b>Control System &amp; Dimming Level</b>	
0-10V - 10% Dimming	LD1
0-10V - 1% Dimming	L11
Low Voltage, PoE compatible (No driver. Not available with EM or EC. LV Voltage only.)	LVN
<b>Lutron Hi-Lume EcoSystem (LDE1) - 1% Dimming</b>	LH1
DALI 1% Dimming (Not available with 1000LF or 1250LF)	D11
<b>Mounting</b>	
24" Cable Suspension	C24_
48" Cable Suspension	C48_
96" Cable Suspension	C96_
<small>(Specify canopy color, see finishes page for options. Example: White = C24WH.)</small>	
<small>(Specify one of the following in place of "C" J - for 2" canopies at non-feed locations. CS - for sloped ceiling applications.)</small>	
<b>Factory Options</b>	
<small>(See Ordering Guide on page 4 for ordering details for DC, EC, EM &amp; ECD.)</small>	
Black Cord	BKCD
Daylight Circuit	_DC
Auxiliary Circuit	_EC
Backup Battery Pack	_EM
Emergency Control Device <sup>†</sup>	_ECD
<small>†(4' minimum. 120/277 Volt only. Does not meet UL 924.)</small>	
<b>Finish</b>	
<small>(See finishes page for The Naturals options)</small>	
Black	BK
Titanium Silver	TS
Matte White Housing	WH
<b>Luminaire Length</b>	
Specify luminaire/row length in 1' increments	X'
<small>(2' minimum. Leave blank for patterns. Smaller increments available, consult factory.)</small>	
<b>Pattern Options</b>	
<small>(2' minimum length)</small>	
'L' pattern	A' x B'
'U' pattern	A' x B' x C'
Rectangular pattern	A' x B' R
<small>(Consult factory for other pattern options)</small>	

## SEEM 1 INDIRECT SUSPENDED - 4' PERFORMANCE CHART

Lumens per Foot	Delivered Lumens	Asymmetric Optic		Batwing Optic		Dust Cover	
		Tested System Watts	LPW	Tested System Watts	LPW	Tested System Watts	LPW
250LF	1000	9	118	9	119	8	122
375LF	1500	12	126	12	127	12	130
500LF	2000	15	133	15	132	14	137
625LF	2500	19	135	19	135	18	140
800LF	3200	25	132	25	130	24	136
1000LF	4000	31	131	31	129	30	136
1250LF	5000	41	128	40	126	40	131

Based on 3500K, 80 CRI, 4' lengths. Lumen multipliers: 90 CRI = 0.87. Lumen output may vary +/- 5%. Actual wattage may vary +/- 5%.

### INDIRECT ASYMMETRIC OPTIC

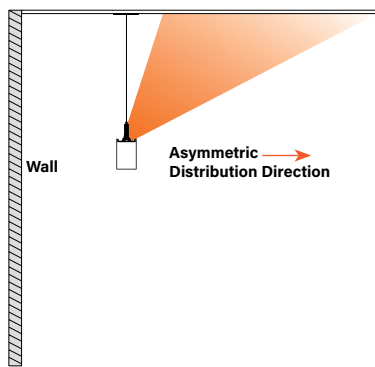

### STANDARD APPLICATION EXAMPLE

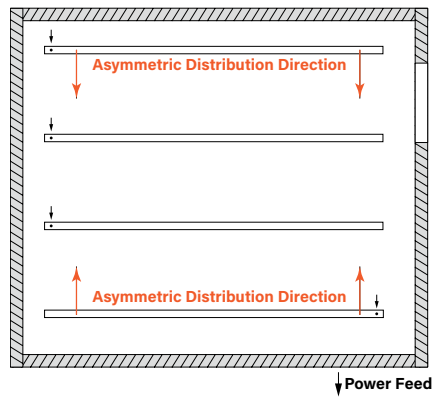

# Ordering Guide

## Linear Circuitry, Zones & Factory Options

### HOW TO USE THIS GUIDE

Fill out the worksheet on the following page to specify your requirements for circuitry, zones, and factory options.

Refer to the run chart for standard run configurations, consult factory for custom configurations.

Complete the Totals / Ordering Codes at the bottom of the worksheet and add to your ordering logic on the cut sheet.

Submit the worksheet along with your order.

TOTAL RUN LENGTH: <u>32ft</u>		JOB NAME: _____			FIXTURE TYPE: _____			
HOUSING SECTION	SECTION LENGTH	SHARED ELECTRICAL FEED, NORMAL POWER			FACTORY OPTIONS			
		SWITCHING CIRCUIT	DIMMING ZONE	DAYLIGHT ZONE	SEPARATE ELECTRICAL FEEDS			EM
DAYLIGHT CIRCUIT	AUXILIARY CIRCUIT				ECD			
1	8	1C	1Z					1EM
2	8	2C	2Z					
3	8	2C	2Z					
4	8				1DC			
<b>Totals / Ordering Codes</b>		<b>2C</b>	<b>2Z</b>		<b>1DC</b>			<b>1EM</b>

ORDERING: FSM1IS-DC-625LF-35K- **2C2Z** -UNV-LD1-C24WH- **1DC-1EM** -WH-32ft

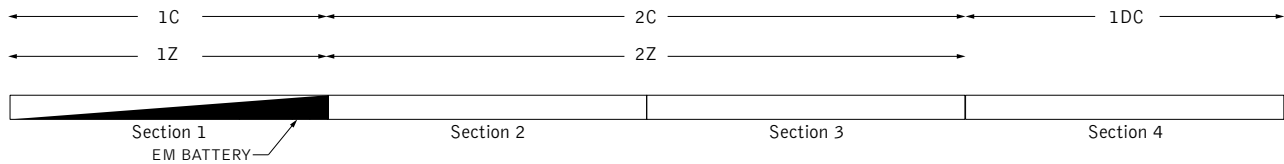

### KEY

#### C = Switching Circuit

Switched Hot / Shared Neutral

#### Z = Dimming Zone

Dimming Control Wires

#### DL = Daylight Zone

Daylight Dimming Control Wires

#### DC = Daylight Circuit

Switched Hot / Separate Neutral

#### EC = Auxiliary Circuit

Switched Hot / Separate Neutral

#### EM = Backup Battery Pack

Unswitched Hot / Shared Neutral

#### ECD = Emergency Control Device

Unswitched Hot / Separate Neutral

### DEFAULTS

- Zones and Factory Options illuminate entire sections from 4' to 8' in length.
- One shared or isolated circuit and zone required per housing section.
- Limit of one EM or ECD per housing section.
- Additional electrical feed required for applications greater than three shared circuits and zones.
- Each DC, EC and ECD require an additional electrical feed.
- ECD not available in the same housing section as EC.
- Longer lead times and additional pricing may apply for custom run configurations.

### CUSTOM LENGTHS

- If partial illumination of emergency or daylight section is required, indicate in ordering guide and add "partial illumination" in Order Notes. Drawing required.
- Engineering validation required, longer lead times may apply.

# Ordering Guide Worksheet

Linear Circuitry, Zones & Factory Options

TOTAL RUN LENGTH: _____		JOB NAME: _____			FIXTURE TYPE: _____			
HOUSING SECTION	SECTION LENGTH	SHARED ELECTRICAL FEED, NORMAL POWER			FACTORY OPTIONS			
		SWITCHING CIRCUIT	DIMMING ZONE	DAYLIGHT ZONE	SEPARATE ELECTRICAL FEEDS			EM
DAYLIGHT CIRCUIT	AUXILIARY CIRCUIT				ECD			
1								
2								
3								
4								
5								
6								
7								
8								
9								
10								
11								
12								
13								
14								
15								
16								
17								
18								
19								
20								
<b>Totals / Ordering Codes</b>								

WORKSHEET

Combine to create Circuits & Zones ordering code

Enter as individual Factory Options

## RUN CHART

Run length (ft)	Housing Configuration Section Lengths	Run length (ft)	Housing Configuration Section Lengths	Run length (ft)	Housing Configuration Section Lengths	Run length (ft)	Housing Configuration Section Lengths
9	5 + 4	21	8 + 8 + 5	33	8 + 8 + 8 + 5 + 4	45	8 + 8 + 8 + 8 + 8 + 5
10	6 + 4	22	8 + 8 + 6	34	8 + 8 + 8 + 6 + 4	46	8 + 8 + 8 + 8 + 8 + 6
11	7 + 4	23	8 + 8 + 7	35	8 + 8 + 8 + 7 + 4	47	8 + 8 + 8 + 8 + 8 + 7
12	8 + 4	24	8 + 8 + 8	36	8 + 8 + 8 + 8 + 4	48	8 + 8 + 8 + 8 + 8 + 8
13	8 + 5	25	8 + 8 + 5 + 4	37	8 + 8 + 8 + 8 + 5		
14	8 + 6	26	8 + 8 + 6 + 4	38	8 + 8 + 8 + 8 + 6		
15	8 + 7	27	8 + 8 + 7 + 4	39	8 + 8 + 8 + 8 + 7		
16	8 + 8	28	8 + 8 + 8 + 4	40	8 + 8 + 8 + 8 + 8		
17	8 + 5 + 4	29	8 + 8 + 8 + 5	41	8 + 8 + 8 + 8 + 5 + 4		
18	8 + 6 + 4	30	8 + 8 + 8 + 6	42	8 + 8 + 8 + 8 + 6 + 4		
19	8 + 7 + 4	31	8 + 8 + 8 + 7	43	8 + 8 + 8 + 8 + 7 + 4		
20	8 + 8 + 4	32	8 + 8 + 8 + 8	44	8 + 8 + 8 + 8 + 8 + 4		

Standard run configurations, consult factory for custom configurations.

# Finishes



## STANDARD FINISHES



WHITE WH BLACK BK TITANIUM SILVER TS

## THE NATURALS (25% SCALE)



LIGHT OAK LOK GRAY ELM GRE CHESTNUT CHT WALNUT WLT WOVEN LINEN WLN