

Apollo 8 LED Ambient + Exam + Reading Light

LED

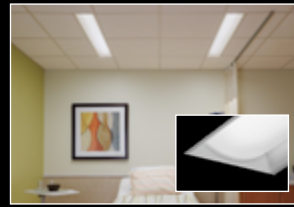

ambient function

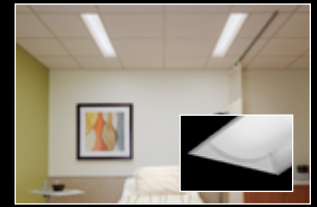

exam function

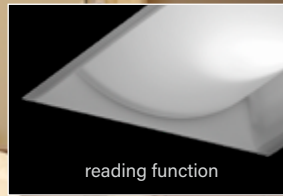

reading function



companion ambient only



companion ambient + exam pair

(exam function shown)

DIMENSIONAL DATA

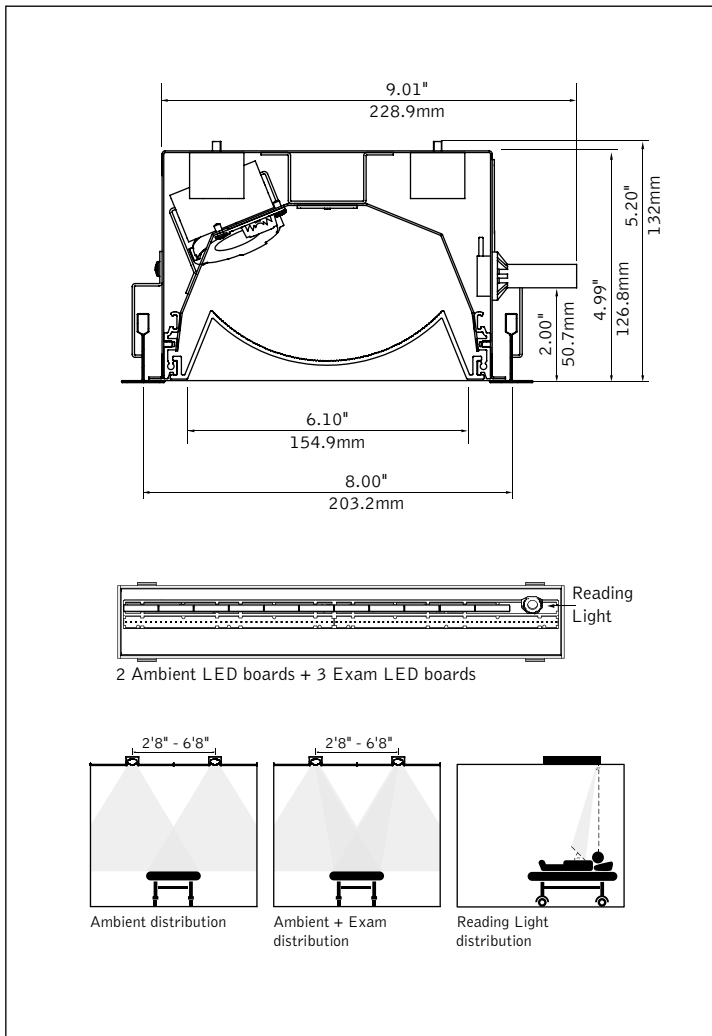

FEATURES

8" wide ambient recessed patient bed light pair with exam and reading light functions.

Radial extruded acrylic diffuser with internal ribs provides brightness control, even illumination, and easy wipe down for cleaning.

Sold as tandem luminaires with master and satellite connected by a low voltage whip. Single power feed allows for easy maintenance.

Custom Curbell dimmable low voltage controller option enables dimming capabilities from a bedside pillow speaker.

PERFORMANCE

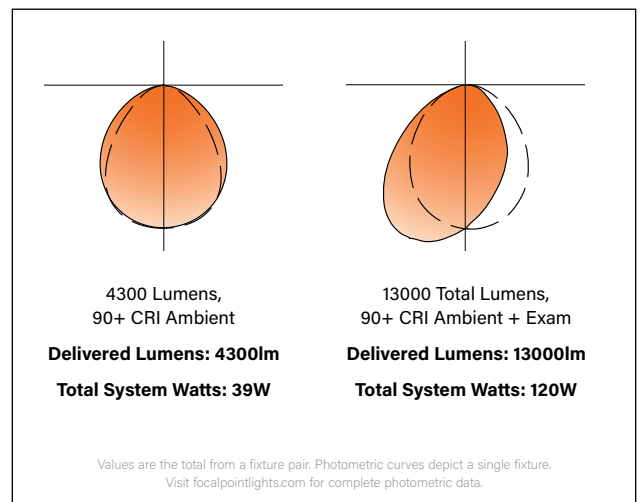

fixture:

project:

MOUNTING INFORMATION

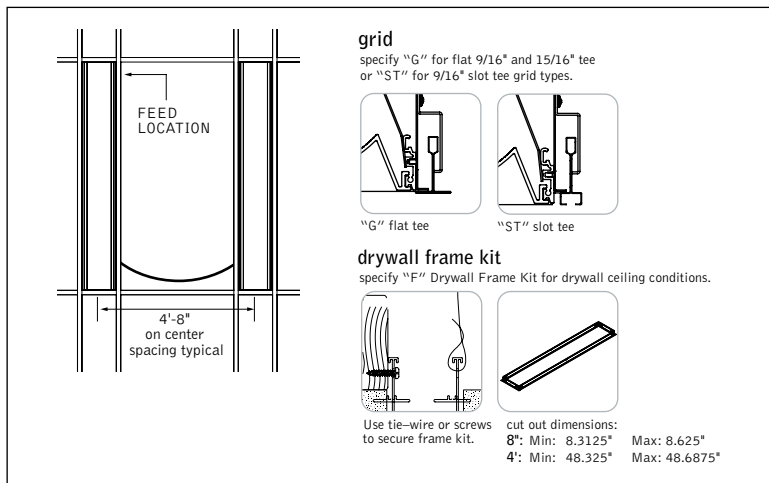

SPECIFICATIONS

LED System

Proprietary linear LED module incorporates premium LEDs on a robust platform to achieve excellent thermal management. LEDs are placed to promote a uniform appearance. Ambient/Exam functions available in 3000K, 3500K, 4000K and 5000K. Reading Light available in 2700K, 3000K and 3500K. All functions available in both 80+ and 90+ CRI options. 3500K and 4000K with CRI>90 have a cyanosis observation index (COI) of 3.3 or less. 0-10V dimming driver standard. LED modules and drivers are replaceable from below. Color accuracy <3 SDCM.

Construction

20 Ga. Steel housing. LEDs sealed and enclosed by detachable acrylic diffuser. End of lens sealed by silicone gasket. Side access plate for electrical connection. Positional clips standard. Fixture pair weight 42.0lbs

Optic

One piece 18 Ga. Aluminum reflector finished in matte white. Exam LEDs are asymmetrically angled to focus light on the center of the bed. An additional focusing optic is used on Exam LEDs for 11000L, 12000L, 13000L outputs. Reading lights are angled 15° for visual comfort.

Electrical

An optional Low Voltage Controller (LVC) allows control of the light sources from a pillow speaker, bed communication side rail device, or momentary dry contact switch. The LVC is configurable to operate with one to three switches, depending on the number of light sources in the fixture and the configuration of buttons on the pillow speaker. The controller also enables dimming of the light sources. It is FCC compliant and will not cause harmful interference. LVC leads are factory labeled.

Labels

UL and cUL listed. UL Certified IP65 per IEC 60529 ensures that the enclosure is dust-tight and protected against jet streams of water from any direction without any harmful effects.

Finish

Antimicrobial polyester powder coat applied over a multi-stage pre-treatment.

Lumen Maintenance

Ambient	Reported: L70 > 61,000 hours L90 > 61,000 hours	Calculated: L70 at 480,000 hours L90 at 128,000 hours
Reading Light	Reported: L70 > 55,000 hours L90 > 55,000 hours	Calculated: L70 at 422,000 hours L90 at 109,000 hours

Derived from EPA TM-21 calculator. Based on typical conditions, consult factory for additional data.

Reliability

At Focal Point, our products are designed to stand the test of time. Each luminaire is engineered using superior components, manufactured with the utmost care and rigorously tested. Contact us for reliability data.

Warranty

LED system rated for operation in ambient environments up to 25°C. 5-year limited warranty.

SEE PAGE 3 FOR PERFORMANCE CHART

ORDERING

Luminaire Series (Always sold in pairs)	FMA8LR
Apollo 8 Ambient + Exam + Reading Light	
Nominal Size 8" x 4'	84
Shielding Radial Acrylic Lens	RA
Pair Total - Lumen Output 2800 Lumens Ambient, 10300 total with Exam	10300L
4300 Lumens Ambient, 10400 total with Exam	10400L
5700 Lumens Ambient, 10500 total with Exam	10500L
2800 Lumens Ambient, 11000 total with Exam	11000L
4300 Lumens Ambient, 12000 total with Exam	12000L
5700 Lumens Ambient, 13000 total with Exam	13000L
<small>(Consult factory for custom lumen options)</small>	
Ambient/Exam Color Temperature 3000K, 80+ CRI or 90+ CRI	30K or 930K
3500K, 80+ CRI or 90+ CRI	35K or 935K
4000K, 80+ CRI or 90+ CRI	40K or 940K
5000K, 80+ CRI or 90+ CRI	50K or 950K
Pair Total - Reading Light Lumen Output 1700 Lumens	1700L
2100 Lumens	2100L
2500 Lumens <small>(80+ CRI only)</small>	2500L
Reading Light Color Temperature 2700K, 80+ CRI or 90+ CRI	27K or 927K
3000K, 80+ CRI or 90+ CRI	30K or 930K
3500K, 80+ CRI or 90+ CRI	35K or 935K
Circuit Three Circuit	3C
Voltage 120 Volt	120V
277 Volt	277V
347 Volt <small>(L11 & all LVC options only. Transformer required for all LVC options.)</small>	347V
Control System & Dimming Level <small>(3 drivers per fixture pair)</small>	
0-10V - 1% Dimming	L11
0-10V - 10% Dimming	LD1
Lutron Hi-Lume EcoSystem (LDE1) - 1% Dimming	LH1
DALI - 1% Dimming	D11
Step Dimming <small>(Ambient & Reading Light dimming, Exam on/off only)</small>	SD5
Low Voltage Controller - On/Off <small>(2-button pillow speaker - Ambient & Reading Light control)</small>	LVCB
Low Voltage Controller - 1% Dimming <small>(2-button pillow speaker - Ambient & Reading Light control)</small>	LVC1B
Low Voltage Controller - Step Dimming <small>(2-button pillow speaker - Ambient & Reading Light control)</small> <small>(Consult factory for alternate LVC wiring configurations or Acuity nLight & Wattstopper DLM options)</small>	LVPCB
Mounting	
Drywall Frame Kit	F
Grid	G
Slot Tee	ST
Factory Options	
Chicago Plenum <small>(Not available with Flex Whip. Consult factory for fixture spacing greater than 4'-8")</small>	CP
Emergency Circuit <small>(Consult factory for LVC options.)</small>	EC
Emergency Circuit with Generator Transfer Device <small>(120 & 277 Volt only. Not available with EC.Ambient only, consult factory for exam, reading or LVC options)</small>	ECGT
6' New York City Flex Whip	FNY
6' Flex Whip	FW
IP65 Rated <small>(Not available with Flex Whip. Consult factory for fixture spacing greater than 4'-8")</small>	IP65
Finish	WHA
Matte Satin White Antimicrobial	WHA

FIXTURE PAIR PERFORMANCE CHART (FMA8LR) - AMBIENT + EXAM FUNCTIONS

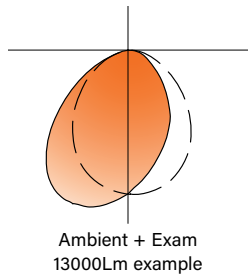
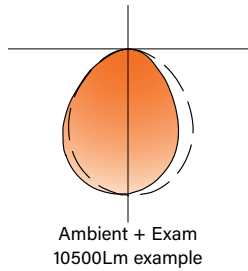
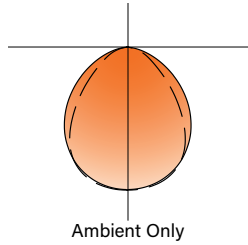

Lumen Output	Function	Delivered Lumens	80+ CRI		90+ CRI	
			Tested System Watts	LPW	Tested System Watts	LPW
10300	Ambient Only	2800	22	130	25	112
	Ambient + Exam	10300	87	120	100	103
10400	Ambient Only	4300	34	127	39	110
	Ambient + Exam	10400	85	122	99	105
10500	Ambient Only	5700	45	126	52	109
	Ambient + Exam	10500	84	124	98	107
11000	Ambient Only	2800	22	130	25	112
	Ambient + Exam	11000	91	120	105	103
12000	Ambient Only	4300	34	127	39	110
	Ambient + Exam	12000	103	120	118	104
13000	Ambient Only	5700	45	126	52	109
	Ambient + Exam	13000	104	122	120	105

Values are the total from a fixture pair, 3500k. Lumen output may vary +/- 5%. Actual wattage may vary +/- 5%. Photometric curves depict a single fixture.

FIXTURE PAIR PERFORMANCE CHART - READING FUNCTION

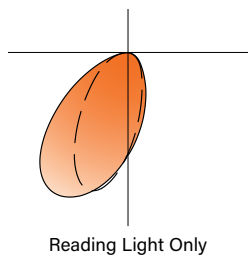

Lumen Output	Function	Delivered Lumens	80+ CRI		90+ CRI	
			Tested System Watts	LPW	Tested System Watts	LPW
1700	Reading	1700	19	90	23	74
2100	Reading	2100	24	88	30	71
2500	Reading	2500	29	86	-	-

Values are the total from a fixture pair, 3500k. Lumen output may vary +/- 5%. Actual wattage may vary +/- 5%. Photometric curves depict a single fixture.

Visit focalpointlights.com for complete specification information.