

Equation™ 2 2x2

LED

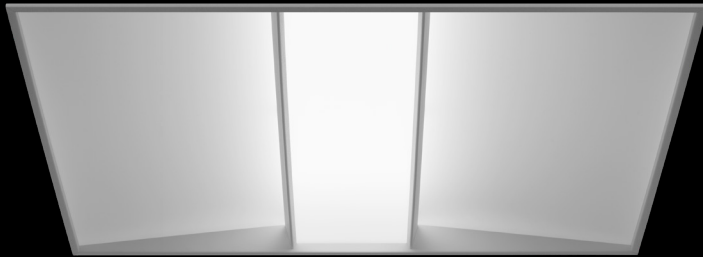

opal acrylic lens

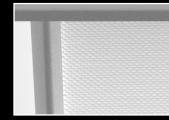

MicroGlow lens

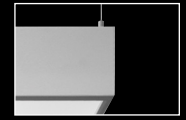

suspended or surface mount

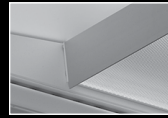

air return

DIMENSIONAL DATA

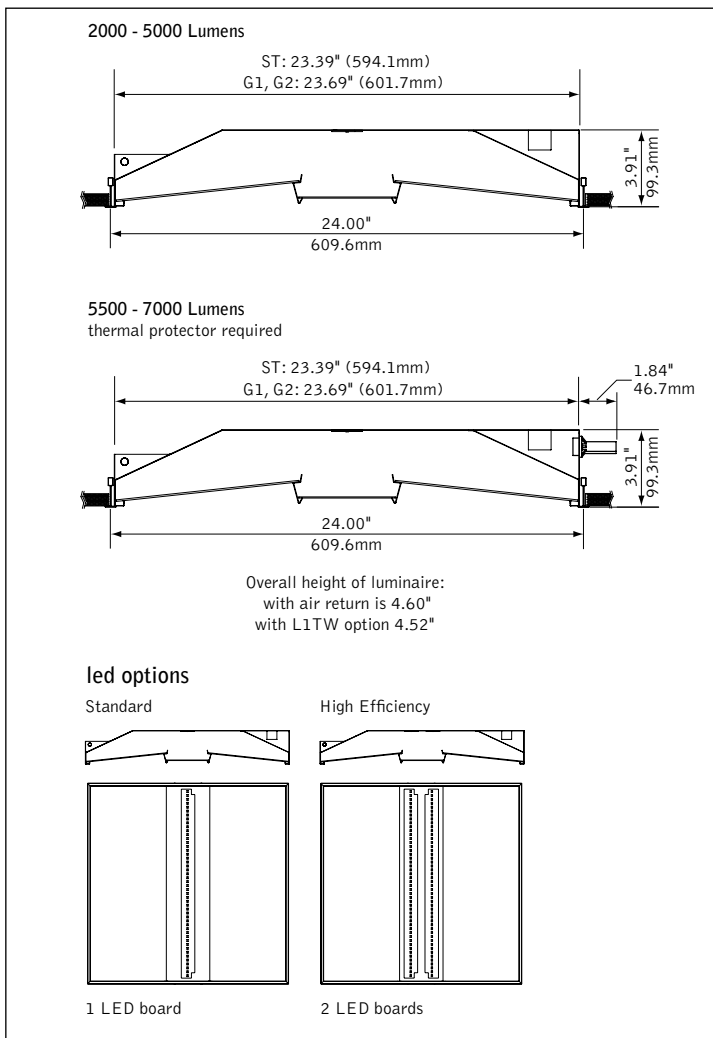

FEATURES

Equation™ 2 blends sleek aesthetics with uniform diffuse illumination.

Center diffuser features MicroGlow prismatic lens for brightness control and visual comfort. Opal acrylic center lens may also be specified.

Tunable White: Supports human activity, well-being, and preferences with a light quality that evolves throughout the day.

Connected Solutions: Integrates with wired and wireless building lighting control systems.

PoE compatible: Integrates with Power over Ethernet lighting systems via standard, low-voltage wires.

PERFORMANCE

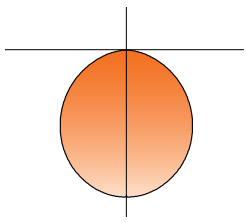

PRODUCT OVERVIEW

Lumen Output: 2000-7000lm

Wattage: 20-79W

LPW: 89-109

SDCM: 3

Opal Acrylic Lens

Delivered Lumens: 3500lm

Total System Watts: 35W

Photometric performance is measured in accordance with IESNA LM-79. Visit focalpointlights.com for complete photometric data.

fixture:

project:

MOUNTING INFORMATION

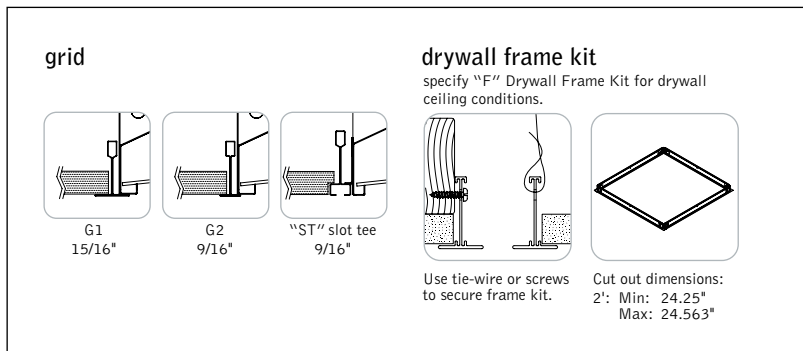

SPECIFICATIONS

LED System

Proprietary linear LED module incorporates premium LEDs on a robust platform to achieve excellent thermal management. LEDs are placed to promote a uniform appearance. Available in 2700K, 3000K, 3500K, 4000K or Tunable White (2700K-6500K), with CRI>80 or CRI>90, 3SDCM. 3500K and 4000K with CRI>90 have a cyanosis observation index (COI) of 3.3 or less. Contact factory for additional color temperature and CRI options. 0-10V dimming driver standard. LED modules and drivers are replaceable from below.

Construction

One-piece 24 Ga. steel reflector and housing. Bottom access 24 Ga. steel driver compartment. Positional brackets supplied as standard. Standard weight: 15.4 lbs. Surface-mount/suspended weight: 19 lbs.

Optic

24 Ga. steel reflectors finished in matte satin white powder coat. .080" thick frosted white acrylic diffusers. Center shielding options include .080" thick opal acrylic lens or MicroGlow prismatic lens with optical filter overlay.

Electrical

Standard 120-277V driver includes 0-10V analog dimming. Power factor > .9. Optional DALI, Lutron EcoSystem or Step-dimming drivers available. PoE compatible: Integrates with Power over Ethernet lighting systems via standard, low-voltage wires.

Emergency

Emergency battery output—10 watts for 90 minutes. Emergency Circuit with Connected Solutions (DLM1, LMFS1, LMFS0, NLT1, ENL1, CLM1, NXE1, WLXP) requires a UL924 compliant device, consult factory.

Labels

UL and cUL listed. Suitable for Dry or Damp Locations, indoor use only.

Finish

Polyester powder coat applied over a multi-stage pre-treatment.

Lumen Maintenance

Reported: L70 at >61,000 hours Calculated: L70 at 190,000 hours
L80 at >61,000 hours L80 at 115,000 hours
(Derived from EPA TM-21 calculator. Based on typical conditions, consult factory for additional data.)

Reliability

At Focal Point, our products are designed to stand the test of time. Each luminaire is engineered using superior components, manufactured with the utmost care and rigorously tested. Contact us for reliability data.

Warranty

LED system rated for operation in ambient environments up to 25°C. 5-year limited warranty.

STANDARD WHITE PERFORMANCE CHART

Lumen Output				Lumen Output			
Tested System Watts		LPW	Tested System Watts		LPW		
2000	2000L	18	106	4000	4000LH	37	105
2500	2500L	24	100	4500	4500LH	43	103
	2500LH	23	105	5000	5000LH	49	100
3000	3000L	30	97	5500	5500LH	56	94
	3000LH	27	107	6000	6000LH	63	95
3500	3500L	36	95	6500	6500LH	71	92
	3500LH	32	107	7000	7000LH	79	89

Based on 3500K, 80 CRI, Opal Acrylic Lens. Lumen multipliers: 90+ CRI = 0.87, MicroGlow Prismatic Lens = 0.94. Lumen output may vary +/- 5%. Actual wattage may vary +/- 5%.

STANDARD WHITE Luminaire Series

		FEQ2
Equation 2	FEQ2	
Nominal Size	2' x 2'	22
Shielding	Opal Acrylic Lens	AC
	MicroGlow Prismatic Lens	MG
Lumen Output	2000 Lumens	2000L
	2500 Lumens	2500L
	3000 Lumens	3000L
	3500 Lumens	3500L
Standard Output	2500 Lumens	2500LH
	3000 Lumens	3000LH
	3500 Lumens	3500LH
High Efficiency	4000 Lumens	4000LH
	4500 Lumens	4500LH
	5000 Lumens	5000LH
	5500 Lumens*	5500LH
	6000 Lumens*	6000LH
	6500 Lumens*	6500LH
	7000 Lumens*	7000LH
	(*Grid, Slot Tee Only)	
Color Temperature	2700K, 80+ CRI or 90+ CRI	27K or 927K
	3000K, 80+ CRI or 90+ CRI	30K or 930K
	3500K, 80+ CRI or 90+ CRI	35K or 935K
	4000K, 80+ CRI or 90+ CRI	40K or 940K
Circuit	Single Circuit	1C
Voltage	UNV 120/277 Volt	UNV
	(Not available with 5500LH, 6000LH, 6500LH & 7000LH)	
	120 Volt	120
	277 Volt	277
	347 Volt	347
	(Transformer required for all drivers except LD1 and CLM1. Not available with EM.)	
	Low Voltage	LV
Control System & Dimming Level	0-10V - 10% Dimming	LD1
	(Not Right Light as standard, consult factory)	
	0-10V - 1% Dimming	L11
	Low Voltage, PoE compatible	LVN
	(No driver. Not available with EM. LV Voltage only)	
	Lutron Hi-Lume EcoSystem (LDE1) -	LH1
	1% Dimming	
	DALI - 1% Dimming	D11
	Step Dimming	SD5
	Wattstopper DLM - 1% Dimming*	DLM1
	(Not available with CP)	
	Wattstopper Fixture Sensor*	LMFS1
	Low Density - 1% Dimming	
	Wattstopper Fixture Sensor	LMFS0
	High Density - 1% Dimming	
	Acuity nLight - 1% Dimming*	NLT1
	(Not available with CP)	
	Enlight Smart Sensor - 1% Dimming*	ENL1
	Encelium CLM Connected Lighting Module*	CLM1
	- 1% Dimming	
	Current NX Enabled - 1% Dimming*	NXE1
	(Not available with CP)	
	WaveLinX Pro - 1% Dimming*	WLXP
	*Not available with EM.	
Mounting	24" Aircraft Cable	C24
	48" Aircraft Cable	C48
	96" Aircraft Cable	C96
	Drywall Frame Kit	F
	(Not available with CLM1, DLM1, NLT1 or NXE1) (Cut out dimensions: Min: 24.25"/Max: 24.563")	
	15/16" Grid	G1
	9/16" Grid	G2
	Slot Tee	ST
	Surface Mount	SM
	(Not available with CLM1, DLM1, NLT1 or NXE1)	
Factory Options	Air Return	AR
	(Overall height with Air Return is 4.62"-4.89")	
	Chicago Plenum	CP
	(Not available with flex whip)	
	Emergency Battery	EM
	with Integral Test Switch (Cannot combine with 347V Not available with 5500LH, 6000LH, 6500LH & 7000LH)	
	6' New York City Flex Whip (120V)	FNY1
	6' New York City Flex Whip (277V)	FNY2
	6' Flex Whip	FW
Finish	Matte Satin White	WH



Options in orange qualify for the Quickship program. 5-day up to 100 pieces, 10-day up to 300 pieces. Refer to Quickship Guide for complete details.

fixture:

project:

MOUNTING INFORMATION

grid

drywall frame kit
specify "F" Drywall Frame Kit for drywall ceiling conditions.

Use tie-wire or screws to secure frame kit. Cut out dimensions: 2': Min: 24.25" Max: 24.563"

TUNABLE WHITE PERFORMANCE CHART

Lumen Output		Delivered Lumens	Tested System Watts	LPW
2000	2000L	2001	24	82
2500	2500L	2508	30	83
	2500LH	2510	29	85
3000	3000L	2999	37	81
	3000LH	3000	34	89
3500	3500L	3511	43	81
	3500LH	3503	39	89
4000	4000LH	3999	45	89
4500	4500LH	4508	51	89
5000	5000LH	5008	61	83
5500	5500LH	5501	68	81
6000	6000LH	6003	74	81
6500	6500LH	6516	81	81

Based on 2700K, 80 CRI, Opal Acrylic Lens. Lumen output may vary +/- 5%. Actual wattage may vary +/- 5%.

Lumen Multipliers

CRI	Multiplier
80+	1.00
90+	0.89
Shielding	Multiplier
AC	1.00
MG	0.94

Wattage Multipliers











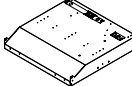

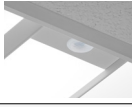



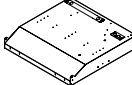

CCT	Multiplier
2700K	1.00
3000K	0.92
3500K	0.88
4000K	0.86
5000K	0.85
5700K	0.87
6500K	0.90

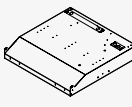

TUNABLE WHITE Luminaire Series

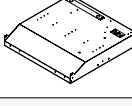
Equation 2	FEQ2
Nominal Size	22
2' x 2'	22
Shielding	
Opal Acrylic Lens	AC
MicroGlow Prismatic Lens	MG
Lumen Output	
Standard	
2000 Lumens	2000L
2500 Lumens	2500L
3000 Lumens	3000L
3500 Lumens	3500L
High Efficiency	
2500 Lumens	2500LH
3000 Lumens	3000LH
3500 Lumens	3500LH
4000 Lumens	4000LH
4500 Lumens	4500LH
5000 Lumens	5000LH
5500 Lumens*	5500LH
6000 Lumens*	6000LH
6500 Lumens*	6500LH
(*Grid, Slot Tee Only)	
Color Temperature	
Tunable White: 2700-6500K, 80+ CRI	2765T
Tunable White: 2700-6500K, 90+ CRI	92765T
Circuit	1C
Single Circuit	1C
Voltage	
UNV 120/277 Volt (5000 Lumens max.)	UNV
120 Volt	120
277 Volt	277
Control System & Dimming Level	
0-10V - 1% Dimming (Not available with surface or cable mount. Overall luminaire height increases to 4.52")	L1TW
DALI - 1% Dimming (Default driver offers DT6 control. It requires two addresses, one for intensity & one for CCT tuning. Consult factory for DT8. Extended lead time applies.)	D1TW
Mounting	
24" Aircraft Cable (Not available with L1TW)	C24
48" Aircraft Cable (Not available with L1TW)	C48
96" Aircraft Cable (Not available with L1TW)	C96
Drywall Frame Kit (Cut out dimensions: Min: 24.25"/Max: 24.563")	F
15/16" Grid	G1
9/16" Grid	G2
Slot Tee	ST
Surface Mount (Not available with L1TW)	SM
Factory Options	
Air Return (Overall height with Air Return is 4.62"-4.89")	AR
Chicago Plenum (Not available with flex whip)	CP
Emergency Battery with Integral Test Switch (4500 Lumen max.)	EM
6' New York City Flex Whip (120V)	FNY1
6' New York City Flex Whip (277V)	FNY2
6' Flex Whip	FW
Finish	WH
Matte Satin White	WH

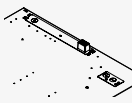
Focal Point provides flexibility in meeting the needs of each project by integrating with several building lighting control systems. A variety of sensors, drivers and other components can be specified that allow the luminaires to communicate with wired and wireless networks. All zoning can be digitally reconfigured through the application software. Daylight harvesting, occupancy sensing, integration with HVAC systems, and individual controls enable the monitoring and modulating of light levels and temperature in order to save energy, reduce costs and maximize occupants' comfort. All Connected Solutions luminaires require a compatible building control system.†

Connected Solution	Ordering Code	Model #**	Protocol	Compatible Networks*	Occupancy & Daylight	Temperature Reporting	Communication to Luminaire	Drivers	
 legrand WATTSTOPPER®		DLM1	LMFC-011	DLM	DLM	Enabled	No	Wired 	Advance by Signify , Optotronic by eldoLED
		LMFS1	LMFS-601 & LMF1-111	DLM Wireless	DLM	Enabled	No	Wireless	Advance by Signify
		LMFSF	LMFS-601						Optotronic by eldoLED (Dexal)
 COOPER Lighting Solutions		WLXP	OEM-WAA	WaveLinx Wireless	WaveLinx Pro Trellix	Enabled	No	Wireless (WaveLinx Pro Wireless Area Controller)	Advance by Signify
 CRESTRON		D11	Specified Driver	DALI	Crestron Züm Wireless & SpaceBuilder	Enabled	No	Wired	eldoLED ECOdrive
	L11			0-10V					Advance by Signify
 ENCELIUM		CLM1	ZBHA-CLM-DIM-ENC	ZigBee	Encelium X Light Management System	Enabled	No	Wireless	Optotronic by eldoLED Advance by Signify
 Enlighted		ENL1	SU-5E-IOT	Enlighted RF	Enlighted	Integrated	Yes	Wireless	Advance by Signify
 LUTRON		LH1	LDE1	EcoSystem	Quantum, Energi Savr Node, Energi TriPak	Enabled	No	Wired	Lutron Hi-Lume
 nLIGHT		NLT1	nEPS-60-IO	nLight	nLight	Enabled	No	Wired 	eldoLED ECOdrive , eldoLED SOLOdrive
 NX LIGHTING CONTROLS		NXE1	NXFM-LV	NX	NX Distributed Intelligence	Enabled	No	Wired 	Optotronic by eldoLED

*Not all compatible networks may be listed. **For performance data and additional control system details please visit the connected solutions manufacturer websites. Primary drivers are listed in **bold**. To specify a particular driver please consult factory. †Controls systems supplied by others.